

Mounting accessories Equipment



Mounting accessories

ESD toggle clamps	526
Assembly stands	528
Turntables	531
Assembly frames	531

Dispensing equipment

Dispensing pens	532
Dispensing equipment	532
Consumables	536
Dispensing needles	538
Dispensing equipment Kahnetics	539
Consumables Kahnetics	540
Dispensing needles Kahnetics	540

Workstation lighting

Workstation lighting	541
Magnifier lamps	545

Optical inspection systems

Microscopes	551
Inspection systems	554
Magnifiers	566

Cleaning

Maintenance cleaning	569
Component cleaning	571
Hygiene / Disinfection	573
Antistatic cleaning / coating	574
Cleaning of PCBs and metal parts	575

Chemistry

Maintenance aids	579
Contact / Mechanical greasing	580
Protective lacquers	580
Thermally conductive products	583
Potting compounds	584

ESD toggle clamps

The ESD toggle clamps have been especially developed for all works with electrostatically sensitive components, modules or devices in ESD protective zones (EPA) according to the standard DIN EN 61340-5-1.

ESD vertical toggle clamp

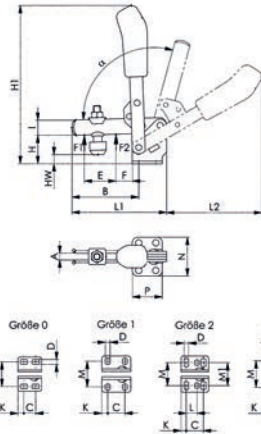

- with protective cap and handle
- electrostatically dissipative material
- with open clamping arm and horizontal base
- galvanized and passivated
- rivet made of stainless steel, which, for sizes 2 and 3, run in hardened bushings
- pre-lubricated bearings
- ergonomic, oil-resistant handle with large grip surface and soft component
- safety clamping piece with finger protection, lock washer for the trust bolt at the end of the clamping arm

Article no.	Size	A	B	C	D	E	F	H
630.6800.0	0	4	31	8.5 - 13.5	4.5	14	5.0	18
630.6800.1	1	5	39	16.0	4.5	18	6.0	19
630.6800.2	2	6	52	20.0	5.5	25	11.0	23
630.6800.3	3	8	79	20.0	7.5	37	19.0	33

Article no.	Size	H1	HW min.	HW max.	I	K	L	L1
630.6800.0	0	81	-1.5	3.5	8	5.5	-	49
630.6800.1	1	98	-4.0	2.0	10	5.5	-	61
630.6800.2	2	140	-3.0	4.5	12	6.0	12.5	78
630.6800.3	3	186	2.0	11.0	18	7.5	-	112

Article no.	Size	L2	M	M1	N	P	a	a*
630.6800.0	0	50	23.0	-	32	22	95°	-
630.6800.1	1	58	22.5 - 26.0	-	34	27	95°	-
630.6800.2	2	89	23.0 - 31.0	27	43	32	105°	60°
630.6800.3	3	112	32.5	-	46	35	105°	60°

dpvlink 24596

Article Type

- 630.6800.0 **ESD vertical toggle clamp type 6800, size 0**
 - clamping screw M4 x 25
 - holding force 0.5 - 0.7 kN
 - weight 60 g
- 630.6800.1 **ESD vertical toggle clamp type 6800, size 1**
 - clamping screw M5 x 30
 - holding force 0.6 - 1.1 kN
 - weight 105 g
- 630.6800.2 **ESD vertical toggle clamp type 6800, size 2**
 - clamping screw M6 x 35
 - holding force 0.8 - 1.2 kN
 - weight 175 g
- 630.6800.3 **ESD vertical toggle clamp type 6800, size 3**
 - clamping screw M8 x 45
 - holding force 1.2 - 2.5 kN
 - weight 410 g

Accessories

- 630.6890.0 ESD Clamping screw type 6890, size 0
- 630.6890.1 ESD Clamping screw type 6890, size 1
- 630.6890.2 ESD Clamping screw type 6890, size 2
- 630.6890.3 ESD Clamping screw type 6890, size 3

ESD Horizontal toggle clamps

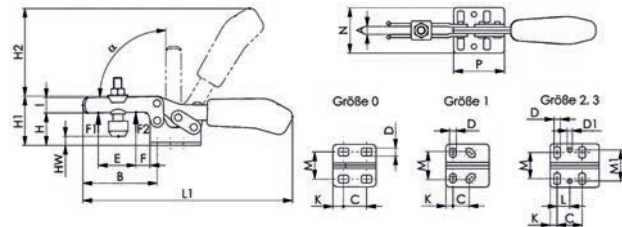

- with protective cap and handle of electrostatically dissipative material
- with open clamping arm and horizontal base
- galvanized and passivated
- rivet made of stainless steel, which, for sizes 2 and 3, run in hardened bushings
- pre-lubricated bearings
- ergonomic, oil-resistant handle with large grip surface and soft component
- lock washer for the trust bolt at the end of the clamping arm

Article no.	Size	A	B	C	D	D1	E	F
630.6830.0	0	4	28	11.5 - 15.5	4.6	-	9.0	5.5
630.6830.1	1	5	42	13.0 - 14.5	5.2	-	18.7	8.0
630.6830.2	2	6	64	26.0	5.6	5.6	32.0	16.0
630.6830.3	3	8	73	25.7	6.5	5.1	38.0	14.0

Article no.	Size	H	H1	H2	HW min.	HW max.	I	K
630.6830.0	0	41.5	23.0	34	-5.5	0.0	7.5	6.3
630.6830.1	1	19.0	30.0	49	-3.0	2.5	10.0	5.5
630.6830.2	2	24.0	45.0	68	-1.5	5.0	13.2	6.0
630.6830.3	3	32	48.5	86	-2.0	9.0	15.0	7.0

Article no.	Size	L	L1	M	M1	N	P	a
630.6830.0	0	-	79	16.0	-	25.0	25.5	90°
630.6830.1	1	-	120	18.0 - 21.5	-	34.0	34.0	90°
630.6830.2	2	12.7	162	19.5 - 29.5	28.5	42.0	38.0	90°
630.6830.3	3	13.0	206	22.0 - 31.8	31.6	45.5	50.0	90°

dpvlink 24730

Article Type

- 630.6830.0 **ESD Horizontal toggle clamp typ 6830, size 0**
 - clamping screw M4 x 25
 - holding force 0.25 - 0.4 kN
 - weight 35 g
- 630.6830.1 **ESD Horizontal toggle clamp typ 6830, size 1**
 - clamping screw M5 x 30
 - holding force 0.8 - 1.1 kN
 - weight 105 g
- 630.6830.2 **ESD Horizontal toggle clamp typ 6830, size 2**
 - clamping screw M6 x 35
 - holding force 1.0 - 1.2 kN
 - weight 185 g
- 630.6830.3 **ESD Horizontal toggle clamp typ 6830, size 3**
 - clamping screw M8 x 45
 - holding force 1.8 - 2.5 kN
 - weight 320 g

Accessories

- 630.6890.0 ESD Clamping screw type 6890, size 0
- 630.6890.1 ESD Clamping screw type 6890, size 1
- 630.6890.2 ESD Clamping screw type 6890, size 2
- 630.6890.3 ESD Clamping screw type 6890, size 3

ESD Push-pull type toggle clamps

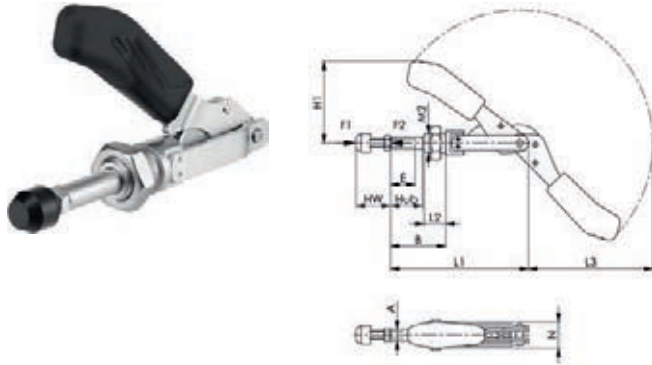

- with protective cap and handle of electrostatically dissipative material
- without angle base
- for push- and pull-clamping (equal operation of rod and lever)
- long rod guide with attaching thread and nut
- galvanized and passivated
- rivet made of stainless steel, which, for sizes 2 and 3, run in hardened bushings
- lever parts and rod of tempered steel
- pre-lubricated bearings
- ergonomic, oil-resistant handle with large grip surface and soft component

Article no.	Size	A	B min.	B max.	E	H1	Hub
630.6840.0	0	6.5	10.5	26.5	13	37.0	16
630.6840.1	1	8.0	17.5	37.5	20	45.5	20
630.6840.2	2	10.0	20.0	46.0	20	66.0	26
630.6840.3	3	12.0	24.0	56.0	30	82.5	32

Article no.	Size	HW min.	HW max.	L1	L2	L3	M2	N
630.6840.0	0	12	20	66.5	10	54	M10 x 1.0	15
630.6840.1	1	12	20	91.0	16	74	M12 x 1.5	18
630.6840.2	2	17	25	114.0	19	105	M16 x 1.5	22
630.6840.3	3	22	35	140.0	22	127	M20 x 1.5	27

dpvlink 24735



Article Type

- | | |
|------------|---|
| 630.6840.0 | ESD Push-pull type toggle clamp type 6840, size 0 <ul style="list-style-type: none"> • clamping screw M4 x 20 • holding force 0.8 - 0.8 kN • weight 60 g |
| 630.6840.1 | ESD Push-pull type toggle clamp type 6840, size 1 <ul style="list-style-type: none"> • clamping screw M4 x 20 • holding force 1.1 - 1.1 kN • weight 100 g |
| 630.6840.2 | ESD Push-pull type toggle clamp type 6840, size 2 <ul style="list-style-type: none"> • clamping screw M6 x 25 • holding force 2.0 - 2.0 kN • weight 245 g |
| 630.6840.3 | ESD Push-pull type toggle clamp type 6840, size 3 <ul style="list-style-type: none"> • clamping screw M8 x 35 • holding force 2.5 - 2.5 kN • weight 330 g |

Accessories

- | | |
|------------|--|
| 630.6880.0 | ESD Clamping screw type 6880, size 0+1 |
| 630.6880.2 | ESD Clamping screw type 6880, size 2 |
| 630.6880.3 | ESD Clamping screw type 6880, size 3 |

ESD Push-pull type toggle clamp

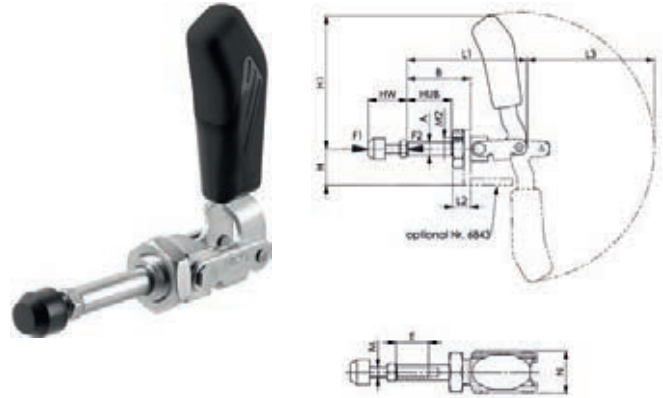

- with protective cap and handle of electrostatically dissipative material
- short design
- for push- and pull-clamping
- long rod guide with attaching thread and nut
- galvanized and passivated
- rivet made of stainless steel
- tempered shoulder screws
- pre-lubricated bearings
- ergonomic, oil-resistant handle with large grip surface and soft component

Article no.	Size	A	B	E	H	H1	Stroke	HW min.
630.6844.2	2	10	36	15	24	73	24.5	17
630.6844.3	3	12	57	25	33	123	40.0	22

Article no.	Size	HW max.	L1	L2	L3	M	M2	N
630.6844.2	2	25	68.5	13	68	M6	M16 x 1.5	30.5
630.6844.3	3	35	108.0	16	115	M8	M20 x 1.5	33.0

dpvlink 24741



Article Type

- | | |
|------------|---|
| 630.6844.2 | ESD Push-pull type toggle clamp type 6844, size 2 <ul style="list-style-type: none"> • clamping screw M6 x 25 • holding force 1.0 - 1.0 kN • weight 130 g |
| 630.6844.3 | ESD Push-pull type toggle clamp type 6844, size 3 <ul style="list-style-type: none"> • clamping screw M8 x 35 • holding force 2.5 - 2.5 kN • weight 320 g |

Accessories

- | | |
|------------|--|
| 630.6880.0 | ESD Clamping screw type 6880, size 0+1 |
| 630.6880.2 | ESD Clamping screw type 6880, size 2 |
| 630.6880.3 | ESD Clamping screw type 6880, size 3 |

ESD Clamping screw type 6880

NEU 

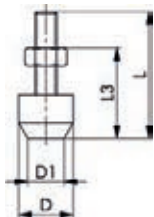

- with protective cap of electrostatically dissipative material
- for push-pull toggle clamp, tempered, galvanized and passivated
- tensile strength class 8.8
- with nut and removable protective cap

Article no.	Size	Screw DIN 933	D	D1	L	L3
630.6880.0	0	M4 x 20	11.0	7	27	12 - 20
630.6880.2	2	M6 x 25	15.0	10	35	17 - 25
630.6880.3	3	M8 x 35	19.5	13	48	22 - 35

dpvlink 24744



Article Type

630.6880.0	ESD Clamping screw type 6880, size 0+1
	<ul style="list-style-type: none"> • M4 x 20 • weight 4 g
630.6880.2	ESD Clamping screw type 6880, size 2
	<ul style="list-style-type: none"> • M6 x 25 • weight 15 g
630.6880.3	ESD Clamping screw type 6880, size 3
	<ul style="list-style-type: none"> • M8 x 35 • weight 26 g

ESD Clamping screw type 6890

NEU 

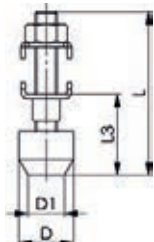

- with protective cap of electrostatically dissipative material
- for open clamping arms, tempered, galvanized and passivated
- tensile strength class 8.8
- with removable protective cap and nut/washer element

Article no.	Size	Screw DIN 933	U-washer size	D	D1	L	L3
630.6890.0	0	M4 x 25	0	11.0	7	32	13 - 20
630.6890.1	1	M5 x 30	1	12.5	8	38	17 - 24
630.6890.2	2	M6 x 35	2	15.0	10	45	18 - 28
630.6890.3	3	M8 x 45	3	15.0	10	58	22 - 34

dpvlink 24748



Article Type

630.6890.0	ESD Clamping screw type 6890, size 0
	<ul style="list-style-type: none"> • M4 x 25 • weight 5 g
630.6890.1	ESD Clamping screw type 6890, size 1
	<ul style="list-style-type: none"> • M5 x 30 • weight 10 g
630.6890.2	ESD Clamping screw type 6890, size 2
	<ul style="list-style-type: none"> • M6 x 35 • weight 22 g
630.6890.3	ESD Clamping screw type 6890, size 3
	<ul style="list-style-type: none"> • M8 x 45 • weight 40 g

Assembly stands

Small vises

The BERNSTEIN ball joint vise has a steplessly adjustable joint head that can be rotated 360° and tilted +/- 45. The upper part of the vise can thus be tilted in any direction and allows for working in front of or above the table. With a simple lever movement, the ESD vise head is released in the conical socket, individually aligned and clamped again. In the EPA the ESD vise is connected to the grounding point with a 10 mm snap via the base.

Spannfix BERNSTEIN small vise with table clamp mounting



- suitable for workbenches with a max. table plate thickness of 80 mm
- fast and easy to mount
- steplessly adjustable

Technical data:

Clamping pressure:	150 kp
Opening of jaws:	70 mm
Clamping depth:	38 mm
Jaw width:	50 mm
Jaws:	plastic exchangeable
Weight:	1.45 kg
Surface resistance R _p : (ESD version)	10 ⁷ - 10 ⁸ Ohm

dpvlink 6943



Article Type

9-205.ESD	Spannfix BERNSTEIN ESD small vise with table clamp mounting ESD version dissipative, color: black
9-205	Spannfix BERNSTEIN small vise with table clamp mounting non-conductive version, color: grey

Spannfix BERNSTEIN small vise with bolt-on baseplate



- baseplate for a permanent mounting with bolts on workbenches and other surfaces
- fixation with four through holes (ø 9 mm)
- steplessly adjustable

Technical data:

Clamping pressure:	1470 N
Opening of jaws:	70 mm
Clamping depth:	38 mm
Jaw width:	50 mm
Jaws:	Plastic, exchangeable
Weight:	1310 g
Baseplate:	150 x 105 mm

dpvlink 6945



Article Type

9-215.ESD	Spannfix BERNSTEIN ESD small vise with bolt-on baseplate ESD version dissipative, color black
9-215	Spannfix BERNSTEIN small vise with bolt-on baseplate non conductive version, color grey

Spannfix BERNSTEIN small vise ESD set



With a simple lever movement, the ESD vise head is released in the conical socket, individually aligned and clamped again. In the EPA the ESD vise is connected to the grounding point with a 10 mm snap via the base.



9-205.ESD.SET1 - consisting of:

- 9-205.ESD Vise with ball joint SPANNFIX with table clamp mounting, dissipative
- 2201.233 Grounding plug, 2 x snap 10 mm / 1 x screw connector with knurled nut (for eyelets M4 / M5)
- 2250.756.10 Grounding cable (smooth cable 1.5m), snap 10 mm / snap 10 mm



9-215.ESD.SET1 - consisting of:

- 9-215.ESD Vise with ball joint SPANNFIX with bolt-on plate, dissipative
- 2201.233 Grounding plug, 2 x snap 10 mm / 1 x screw connector with knurled nut (for eyelets M4 / M5)
- 2250.756.10 Grounding cable (smooth cable 1.5m), snap 10 mm / snap 10 mm

[dpvlink 24629](#)

Article	Type
9-205.ESD.SET1	Spannfix BERNSTEIN ESD SET ESD small vise with table clamp mounting
9-215.ESD.SET1	Spannfix BERNSTEIN ESD SET ESD small vise with bolt-on plate

Spannfix Vario

The SPANNFIX Vario individual elements can be combined arbitrarily.



Application example 1
9-251.ESD
9-253.ESD
9-255.ESD



Application example 2
9-251.ESD
9-252.ESD

Spannfix BERNSTEIN ESD Vario base with table clamp mounting



- with table clamp mounting, for the screwing on workbenches
- max. table plate thickness of 80 mm
- weight: 0.95 kg.

[dpvlink 6964](#)

Article	Type
9-251.ESD	Spannfix BERNSTEIN ESD Vario base with table clamp mounting ESD version, dissipative, color: black
9-251	Spannfix BERNSTEIN Vario base with table clamp mounting not conductive version, color: grey



Spannfix BERNSTEIN ESD Vario base with bolt-on baseplate



- ith screw-on baseplate and threaded pin M 12 x 1.5 for a permanent mounting with bolts
- base plate 150 x 105 mm
- weight: 0.80 kg.

[dpvlink 6966](#)

Article	Type
9-261.ESD	Spannfix BERNSTEIN ESD Vario base with bolt-on baseplate ESD version, color black
9-261	Spannfix BERNSTEIN ESD Vario base with bolt-on baseplate non conductive version, color grey



Spannfix base ESD set



ESD set consisting of:

- 9-205.ESD or 9-215.ESD SPANNFIX Vario ESD base with ball joint, dissipative
- 2201.233 Grounding plug, 2 x snap 10 mm / 1 x screw connector with knurled nut (for eyelets M4 / M5)
- 2250.756.10 Grounding cable (smooth cable 1.5m), snap 10 mm / snap 10 mm

dpvlink 24632

Article	Type
9-251.ESD.SET1	Spannfix BERNSTEIN ESD Vario base with table clamp mounting SET
9-261.ESD.SET1	Spannfix BERNSTEIN ESD Vario base with bolt-on plate SET

Screw head SPANNFIX



Technical data:

- Clamping pressure: 150 kp
- Opening of jaws: 70 mm
- Clamping depth: 38 mm
- Jaw width: 50 mm
- Jaws: Plastic, exchangeable
- Weight: 0.56 kg

dpvlink 6952

Article	Type
9-252.ESD	Screw head ESD SPANNFIX ESD version, dissipative, color: black
9-252	Screw head SPANNFIX non-conductive version, color: grey

PCB holder SPANNFIX



Adjustable span width, arbitrary extension possible at any time, correct clamping by adjusting the center position; firm clamping of the PCB by integrated suspension in the holding bars.

dpvlink 6954

Article	Type
9-253.ESD	PCB holder ESD SPANNFIX 25-270 mm span width, max. height 70 mm, weight: 0.28 kg, ESD version dissipative, color: black

Angular adapter



- usable for any attachable tool allowing an even larger turning radius (article no. 9-253/9.253.ESD)
- weight: 0.095 kg.

dpvlink 6960

Article	Type
9-255.ESD	Angular adapter ESD SPANNFIX ESD version, dissipative, color: black
9-255	Angular adapter SPANNFIX non-conductive version, color: grey

Universal screw-on plate SPANNFIX



- Slots made for common standard screws, for the construction of prototypes or for holding e.g. tuner, line output transformer, loudspeakers etc.
- weight: 95 g

dpvlink 6968

Article	Type
9-254.ESD	Universal screw-on plate ESD SPANNFIX ESD version, color black
9-254	Universal screw-on plate SPANNFIX non conductive version, color grey

Cover plate SPANNFIX for equipped frames



- for the use with 9-253
- covered with 20 mm foam
- components of different sizes are pressed in such a way that after turning the PCB holder a correct soldering is possible
- size of the cover plate: 240 x 130 mm
- weight: 0.26 kg.

dpvlink 6956

Article	Type
9-256	Cover plate SPANNFIX for equipped frames (to 9-253) not conductive version, color: red

Rapid turning device SPANNFIX



- for the use with 9-253 / 9-253.ESD
- with fixed angle adapter
- allows an extremely fast rotation of the PCB holder with PCB and cover plate by 180°
- weight: 0.27 kg.

dpvlink 6962

Article	Type
9-257.ESD	Rapid turning device ESD ESD version, dissipative, color: black

SPANNFIX 4.0

Ball-joint vise SPANNFIX 4.0 with table clamp



- due to the ball joint the head can be rotated by 360° and tilted up to 90°
- 4 clamping pins (rotatable about the axes) can be adjusted to every item in shape and size
- centering lug for vertical work
- profiled jaws (smooth side as well as a side with a edge and two vertical grooves) designed as reversible jaws that can be replaced
- integrated ruler to read the clamping depth directly from the vise
- base including table clamp for mounting the SPANNFIX to even table edges of up to 80 mm as well as to the table corner itself - this is the optimal position to use the entire working radius of 330 mm

Technical data:

Clamping force:	12,000 N
Opening of jaws:	100 mm
Clamping depth:	50 mm
Jaw width:	100 mm
Weight:	5.50 kg

dpvlink 24118

Article	Type
9-290	Spannfix 4.0 vise



Turntables

ESD turntables octagon



- Upper material: conductive, cross-linked PE foam (6 mm), black
- Base: galvanized steel turntable
- very low profile (25 mm)
- load capacity max. 23 kg

In compliance with ESD standard DIN EN 61340-5-1 

dpvlink 18699

Article	Type
5805.47200	ESD turntable
5805.47201	ESD turntable Diameter: 394 mm



Assembly frames

PCSA assembly frames



The assembly frames facilitate the equipping and soldering of PCBs, especially for series production.

The PCB are placed and held between the guide rails by locking knurled nuts. The central rail is removable allowing an optimal use of the working surface.

After the assembly the components are pressed by the cover plate with ESD foam insert. The distance of the pressure plate to the frame is adjustable, the lid is closed by springs. The PCBs are moved back into the working position by the raising and turning of the holder.

During the soldering and cutting, the components are held safely. The holding frame can be simply removed and transported to the next workstation.

In compliance with the ESD standard DIN EN 61340-5-1 

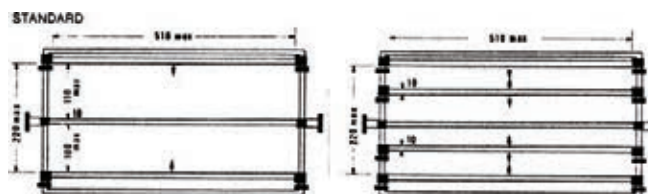

The standard types of PCSA 1-2-3-4 are equipped with 1 central rail and 2 adjustable guide rails.

dpvlink 3036

Article	Type
690.101.ESD	PCSA 1 ESD assembly frame max. PCB size 270 x 220 mm
690.102.ESD	PCSA 2 ESD assembly frame max. PCB size 500 x 220 mm
690.104.ESD	PCSA 4 ESD assembly frame max. PCB size 500 x 350 mm



Accessories

690.201	Additional rail for PCSA 1, complete
690.202	Additional rail for PCSA 2, complete
690.204	Additional rail for PCSA 4, complete

Dispensing pens

Dispensing pen ESD Bonpen



Empty dispensing pen refillable

- 7 different tips for diverse applications
- Excellent for fine and precise application of the flux or other suitable solutions
- Usable for flux, solvents, lubricants, masks and water-based products
- antistatic / ESD version

dpwlink 23097



Article	Type
I-BON-102.ESD	Dispensing pen ESD BON-102 Tip I-BR-102 conical short, fine nylon brush Width 4.3 mm, length 14 mm
I-BON-102B.ESD	Dispensing pen ESD BON-102B Tip I-BR-102B conical short, fine felt Width 4.0 mm, length 9.5 mm
I-BON-102D.ESD	Dispensing pen ESD BON-102D Tip I-BR-102D chisel-shaped flat, fine nylon brush Width 6.2 mm, length 17 mm
I-BON-102F.ESD	Dispensing pen ESD BON-102F Tip I-BR-102F chisel-shaped flat, fine felt Width 4.5 mm, length 10 mm
I-BON-102K.ESD	Dispensing pen ESD BON-102K Tip I-BR-102K chisel-shaped oblique, fine felt Width 4.5 mm, length 12.5 mm
I-BON-102S.ESD	Dispensing pen ESD BON-102S Tip I-BR-102S conical ultrafine and extra short, fine nylon brush Width 2.5 mm, length 10 mm
I-BON-102T.ESD	Dispensing pen ESD BON-102T Tip I-BR-102T conical long, fine nylon brush Width 5.2 mm, length 18 mm
I-BON-102A.ESD	Dispensing pen ESD BON-102A contains dispensing pens Bonpen I-BON-102, I-BON-102B, I-BON-102D, I-BON-102F, I-BON-102K, I-BON-102S, I-BON-102T

Tips Bonpen

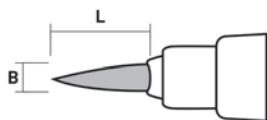

PU: 5 pieces

dpwlink 23098



Article	Version	W [mm]	L [mm]
I-BR-102.ESD	conical shape short, fine nylon brush	4.3	14
I-BR-102B.ESD	conical shape short, fine felt	4.0	9.5
I-BR-102D.ESD	chisel shape flat, fine nylon brush	6.2	17
I-BR-102F.ESD	chisel shape flat, fine felt	4.5	10
I-BR-102K.ESD	chisel shape oblique, fine felt	4.5	12.5
I-BR-102S.ESD	Conical ultrafine and extra short, fine nylon brush	2.5	10
I-BR-102T.ESD	conical shape long, fine nylon brush	5.2	18

Cartridge for dispensing tip Bonpen ESD



dpwlink 23114



Article	Type
I-CA102.ESD	Replacement cartridge for dispensing pen ESD Bonpen Content: 7ccm, PU: 5 pieces

Dispensing equipment

DC150 Dispenser



The analog dispenser DC150 is only recommended for manual dispensing applications. The dispensing process is triggered by pressing the foot switch. The device is a low-cost alternative and ensures continuous dispensing operations with the same precision and quality. It is suitable for all types of media and equipped with vacuum retention to that to avoid dripping of low-viscosity media.

Features:

- Continuous dosing cycle
- Wide application range
- Vacuum retention to prevent dripping
- low-cost, highly reliable system



1. Vacuum retention
2. Compressed air outlet
3. Pressure gauge for compressed air outlet
4. Pressure regulator
5. Power LEDs

Technical data:

Dimensions:	235 x 75 x 220 mm
Dispensing method:	Manual
Input voltage:	85-264 V AC / 50/60 Hz
Working voltage:	24 V DC (incl. foot switch)
Compressed air input:	0-7 bar
Compressed air output:	0.1-7 bar
Weight:	approx. 1.3 kg

Accessory kit (scope of delivery)

	Pieces	
504576	cold-device cable 230V AC	1
504569	foot switch	1
504571	cartridge holder	1
504572	hose for compressed air inlet	1
990180	30cc cartridge adapter	1
801004	30cc cartridge	3
801009	30cc plug	3
990062-K	dispensing needle set small 17-piece	

dpwlink 19869



Article	Type
DC150	DC150 Dispenser incl. standard accessories

DC270 Dispenser with time control



The devices of the **DC 200 dispenser series** are equipped with a timer allowing to adjust a dosing time of 0.01 to 30 seconds. The two available versions can be distinguished by the dimensioning of the compressed air outlet. The DC 200 is designed to control precisely the pneumatically controlled dosing cycles, like e.g. dosing cycles of 3 – 55 cc small cartridges. The integrated pressure regulator allows for a precise pressure.

Features:

- Timer
- Pressure gauge to set the pressure
- wide-range power supply unit 85-264V AC
- Vacuum retention



1. Vacuum retention
2. Compressed air outlet
3. Pressure gauge for compressed air outlet
4. Pressure regulator
5. Power LED
6. Timer ON / OFF
7. Adjustment of period

Technical data:

Dimensions:	235 x 75 x 220 mm
Time range:	0.01 - 31 seconds
Dispensing method:	manual or time-controlled
Input voltage:	85-264 V AC / 50/60 Hz
Working voltage:	24 V DC (incl. foot switch)
Compressed air input:	0-7 bar
Compressed air output:	0.1-7 bar
Weight:	1.3 kg

Accessory kit (scope of delivery)

Article	Type	Pieces
504576	cold-device cable 230V AC	1
504569	foot switch	1
504571	cartridge holder	1
504572	hose for compressed air inlet	1
990180	30cc cartridge adapter	1
801004	30cc cartridge	3
801009	30cc plug	3
990062-K	dispensing needle set small 17-piece	

[dpvlink 19859](#)

Article	Type
DC270	DC270 Dispenser incl. standard accessories



DC370 Dispenser with time control



A digital control of the input pressure and an adjustable pressure limit increase the process reliability of the **DC 300**. The four devices of the DC 300 series can be distinguished by the compressed air output and the optional I/O port allowing an integration of the DC 300 in automated workflows.

Features:

- optional I/O port
- digital display
- cycle operation
- 9 program courses
- input pressure monitoring with integrated pressure sensor and error display
- switchable unit bar/psi
- timer
- pressure gauge for compressed air regulation
- wide-range power supply 85-264V AC
- vacuum retention



1. Vacuum retention
2. Compressed air outlet
3. Pressure gauge for compressed air outlet
4. Pressure regulator
5. 7-segment display
6. Status LEDs
7. Operating keys

Technical data:

Dimensions:	235 x 75 x 220 mm
Time range:	0.01-9999 seconds
Dispensing method:	manual or time-controlled
Input voltage:	85 - 264 V AC
Working voltage:	24 V DC (incl. foot switch)
Compressed air input:	0-7 bar
Compressed air output:	0.1-7 bar
Weight:	1.3 kg

Accessory kit (scope of delivery)

Article	Type	Pieces
504576	cold-device cable 230V AC	1
504569	foot switch	1
504571	cartridge holder	1
504572	hose for compressed air inlet	1
990180	30cc cartridge adapter	1
801004	30cc cartridge	3
801009	30cc plug	3
990062A-G	dispensing needle set large 134-piece	

[dpvlink 19864](#)

Article	Type
DC370	DC370 Dispenser incl. standard accessories



DC600 Dispenser with vacuum tweezers



The vacuum tweezers turn the **DC 600** into the ideal device for pick-and-place applications and for the mounting and reworking of small components. Before positioning the components it is possible to apply solder pastes and other materials with maximum precision. so, the DC600 is suitable for many industrial applications in the miniature field. It is suitable for all types of media. The device is equipped with a vacuum retention system to avoid a dripping of low-viscose media.

Features:

- two functions in one device
- vacuum tweezers
- timer
- vacuum suck-back to avoid dripping
- suitable for dispensing and positioning applications



1. Vacuum retention
2. Compressed air outlet
3. Pressure gauge
4. Pressure regulator
5. Power LED
6. Timer ON / OFF
7. Adjustment of period
8. Connection for vacuum tweezers
9. Vacuum for vacuum tweezers

Technical data:

Dimensions:	260 x 75 x 220 mm
Time range:	0.01-31 seconds
Dispensing method:	manual or time-controlled
Input voltage:	85-264 V AC
Working voltage (incl. foot switch):	24 V DC
Dispensing speed:	600+/minute
Compressed air input:	0-7 bar
Compressed air outlet:	0.1-7 bar
Weight:	1.5 kg

Accessory kit (scope of delivery)		Pieces
504576	cold-device cable 230V AC	1
504569	foot switch	1
504571	cartridge holder	1
504572	hose for compressed air inlet	1
990180	30cc cartridge adapter	1
801004	30cc cartridge	3
801009	30cc plug	3
990062A-G	dispensing needle set large 134-piece	1
560046	tweezers with vacuum function incl. vacuum exhauster mm Ø 3.5 / Ø 5.1 / Ø 6.4 / Ø 8.1 / Ø 10.2 and dispensing needles 45° bent mm Ø 0.5 / Ø 0.8 / Ø 1.6	

dpvlink 17376

Article	Type
DC600	DC600 Dispenser incl. standard accessories



DC1000 Digital dispenser



The digital dispenser of the **DC1000 series** is the ideal entry to the digital dosing technology. The device is operated with the keys on the left and right of the display showing all parameters. Information about dosing time control, teach-in function, program selection, cycle counter, digital pressure monitoring, etc. can be easily read due the simple and self-explanatory display. The device can communicate with PLC or machine control via the standard I/O interface.

Features:

- digital pressure input display
- 8 program channels
- cycle counter
- precision pressure regulator
- Made in Germany



1. Vacuum retention
2. Compressed air outlet
3. Pressure gauge for compressed air outlet
4. Precision pressure regulator
5. Display
6. Status LEDs
7. Operating keys

Technical data:

Dimensions:	260 x 75 x 220 mm
Weight:	1.5 kg
Dosing time:	0.01-999 seconds
Operation mode:	manual or time-controlled
Input voltage:	85-264 V AC
Working voltage:	24 V DC (incl. foot switch)
Compressed air input:	0-7 bar
Compressed air outlet:	0.08-6 bar
Display:	128 x 64 Pixel
Programs:	9 program channels

Accessory kit (scope of delivery)		Pieces
504576	cold-device cable 230V AC	1
504569	foot switch	1
504571	cartridge holder	1
504572	hose for compressed air inlet	1
990180	30cc cartridge adapter	1
801004	30cc cartridge	3
801009	30cc plug	3
990062A-G	dispensing needle set large 134-piece	

dpvlink 25072

Article	Type
DC1020	DC1020 Digital dispenser - max. 2 bar with standard accessories
DC1040	DC1040 Digital dispenser - max. 4 bar with standard accessories
DC1060	DC1060 Digital dispenser - max. 6 bar with standard accessories



DC1100 Digital dispenser



The DC1100 dispenser series is available in different versions differing in the height of the maximal dosing pressure. It is designed to control precisely the pneumatically controlled dosing cycles, like e.g. dosing cycles of 3 – 55 cc small cartridges. The used precision pressure regulator allows adjusting exactly the pressure on the material in the cartridge. The calibration of the vacuum retention is shown on the display. The digital pressure control including display of the input pressure increases the process reliability.

Features:

- timer
- I/O port
- precision pressure regulator
- input pressure control
- backlit display
- digital display of the vacuum retention
- EMC-safe and tested



1. Vacuum retention
2. Compressed air outlet
3. Pressure gauge for compressed air outlet
4. Precision pressure regulator
5. Display
6. Status LEDs
7. Operating keys

Technical data:

Dimensions:	260 x 75 x 220 mm (W x H x D)
Weight:	1.5 kg
Dosing time:	0.01 - 999 Sekunden
Input voltage:	85-264 V AC
Working voltage:	24 V DC (incl. foot switch)
Compressed air input:	up to 7 bar (display: digital)
Compressed air outlet:	0.08 - 6 bar
Vacuum retention:	<ul style="list-style-type: none"> • digital display of all pressures • display as numeric value and level indicator • 3-digit without unit
Display:	128 x 64 Pixel
Programs:	8 program channels

Accessory kit (scope of delivery)

Article	Description	Pieces
504576	cold-device cable 230V AC	1
504569	foot switch	1
504571	cartridge holder	1
504572	hose for compressed air inlet	1
990180	30cc cartridge adapter	1
801004	30cc cartridge	3
801009	30cc plug	3
990062A-G	dispensing needle set large 134-piece	

dplink 25115



Article	Type
DC1120	DC1120 Digital dispenser - max. 2 bar with standard accessories
DC1140	DC1140 Digital dispenser - max. 4 bar with standard accessories
DC1160	DC1160 Digital dispenser - max. 6 bar with standard accessories

DC1200 Digital dispenser



The fully digital DC1200 provides a completely revised display allowing to read all relevant working pressures as level indicator and numeric value. The advantage of the digital display is its precise readability. Dosing pressure, vacuum retention and dosing times can be set and monitored precisely and reproducibly. The DC1200 provides a teach-in function, a program selection with 8 memories, a cycle counter etc. The simple and self-explanatory menu display offers highest ease of use. The device can communicate with PLC or machine control via the standard I/O interface.

Features:

- timer
- I/O port
- precision pressure regulator
- input pressure control
- backlit display
- digital display of the vacuum retention
- EMC-safe and tested



1. Vacuum retention
2. Compressed air outlet
3. Precision pressure regulator
4. Display
5. Status LEDs
6. Operating keys

Technical data:

Dimensions:	260 x 75 x 220 mm (W x H x D)
Weight:	1.5 kg
Dosing time:	0.01 - 999 Sekunden
Input voltage:	85-264 V AC
Working voltage:	24 V DC
Compressed air input:	up to 7 bar (display: digital)
Compressed air outlet:	0.08 - 6 bar
Vacuum retention:	<ul style="list-style-type: none"> • digital display of all pressures • display as numeric value and level indicator • 3-digit without unit
Display:	128 x 64 Pixel
Programs:	8 program channels

Accessory kit (scope of delivery)

Article	Description	Pieces
504576	cold-device cable 230V AC	1
504569	foot switch	1
504571	cartridge holder	1
504572	hose for compressed air inlet	1
990180	30cc cartridge adapter	1
801004	30cc cartridge	3
801009	30cc plug	3
990062A-G	dispensing needle set large 134-piece	

dplink 25119



Article	Type
DC1220	DC1220 Digital dispenser - max. 2 bar with standard accessories
DC1240	DC1240 Digital dispenser - max. 4 bar with standard accessories
DC1260	DC1260 Digital dispenser - max. 6 bar with standard accessories

DC3000 Digital dispenser

NEU 



Nearly all parameters of the dispenser DC 3000 can be set via the touch screen. Only the knobs for dispensing pressure and vacuum retention are located at the housing. The large storage of the DC 3000 allows saving up to 64 program channels. It is possible to arrange and run sequentially one after the other up to five dispensing programs.

Properties:

- Digital pressure display
- 64 program channels
- Color display
- upper and lower limit definable
- pin code allocation



1. Vacuum retention
2. Compressed air outlet
3. Precision pressure regulator
4. 5" Touch screen

Technical data:

Dimensions:	245 x 110 x 115 mm
Weight:	1.5 kg
Dosing time:	0.01-999 seconds
Operation mode:	digital
Input voltage:	85-264 V AC
Working voltage:	24 V DC (incl. foot switch)
Compressed air input:	up to 7 bar
Compressed air outlet:	0.08-6 bar
Programs:	64 program channels

Scope of delivery

		Pieces
504576	cold-device cable 230V AC	1
504569	foot switch	1
504571	cartridge holder	1
504572	hose for compressed air inlet	1
990180	30cc cartridge adapter	1
801004	30cc cartridge	3
801009	30cc plug	3
508530	dispensing needle set large 125-piece	1

dpvlink 26471

Article	Type
DC3000	DC3000 Digital dispenser touch screen incl. standard accessories



DB-815 foot valve dispenser



The DB-815 foot valve dispenser is the robust and cost-efficient dosing unit for simple purposes. The dispensing impulse is controlled by the foot pedal achieving a perfect control of the dispensing process. Liquids of any viscosity can easily be processed.

dpvlink 2880

Article	Type
DB815	DB-815 foot valve dispenser, without vacuum (without accessories)



Consumables

Cartridges PP series 8000 "transparent"

for UV applications



dpvlink 22240

Article	Size in cm ³	Shipping Unit
801001	3	50 piece
801002	5	40 piece
801003	10	30 piece
801004	30	20 piece
801005	55	15 piece



Cartridges PP series 8000 "amber"

for UV applications



dpvlink 22246

Article	Size in cm ³	Shipping Unit
801040	3	50 piece
801041	5	40 piece
801042	10	30 piece
801043	30	20 piece
801044	55	15 piece



Cartridges PP series 8000 "black"

for UV applications



dpvlink 22252

Article	Size in cm ³	Shipping Unit
801045	3	50 piece
801046	5	40 piece
801047	10	30 piece
801048	30	20 piece
801049	55	15 piece



Cartridge adapter series 8000



The cartridge adapter of the series 8000 permits a safe and quick connection of the cartridge to the compressed air socket of the dispenser.

PU = 1 piece

dpvlink 22259

Article	Type
990183	Cartridge adapter 3cc with 1m tube
990182	Cartridge adapter 5 cc with 1m tube
990181	Cartridge adapter 10cc with 1m tube
990180	Cartridge adapter 55/30 cc with 1m tube

Adapter head series 8000



replacement part, incl. O-Ring, for 4/2 tube

PU = 1 piece

dpvlink 22274

Article	Type
990191	Adapter head for 3cc cartridge
990190	Adapter head for 5cc cartridge
990189	Adapter head for 10cc cartridge
990188	Adapter head for 55/33cc cartridge

Plug series 8000



green, polyethylene, with Smooth Flow

dpvlink 22279

Article	Type	Size in cm ³	Shipping Unit
801006	Plug Smooth-Flow green 3cc	3	50 piece
801007	Plug Smooth-Flow green 5cc	5	40 piece
801008	Plug Smooth-Flow green 10cc	10	30 piece
801009	Plug Smooth-Flow green 55/30cc	55 / 30	20 piece

End cap series 8000



green, polyethylene

dpvlink 22284

Article	Type	Size in cm ³	Shipping Unit
801038	Needle cap	3-55	10
801034	Upper end cap 3cc cartridge	3	10
801035	Upper end cap 5cc cartridge	5	10
801036	Upper end cap 10cc cartridge	10	10
801037	Upper end cap 30/55cc cartridge	30 / 55	10

Adapter hose series 8000 for cartridge adapter heads



Replacement part, polyvinyle, transparent.

dpvlink 22294

Article	Type	Internal Ø	External Ø
560780	Adapter hose for cartridge adapter heads	3.0 mm	6.0 mm

Compressed air hose for dispensers and controllers

dpvlink 26510

Article	Type	Internal Ø	External Ø
504509	Compressed air hose for dispensers and controllers	4.0	6.0

Safety clip series 8000



replacement part, for cartridge adapter

dpvlink 22306

Article	Type
5606034	Safety clip for cartridge adapter

Fine filter for compressed air series 8000



Transparent fine filter (10µ) as backflow protection at the compressed air outlet to the dispensing cartridge when dispensing low-viscosity liquids.

- for hose with 4 mm internal diameter
- burst pressure above 3 bar

dpvlink 22308

Article	Type
500942	Fine filter for compressed air hose 504509

Plug "Neoprene"



black

PU = 20 pieces

dpvlink 2854

Article	Type
502799	Plug "Neoprene" for 80cc / 55cc / 30 cc cartridges

Hand piston

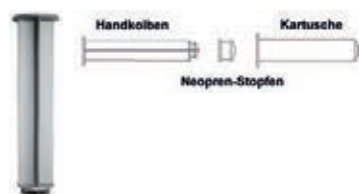

suitable for plugs "Neoprene"

dpvlink 8705

Article	Type	Size in cm ³
560002A-PLR	Hand piston 30cc	30

O-Ring "Buna"



black

PU = 10 pieces

dpvlink 2882

Article	Type
560005B	O-Ring "Buna" for cartridge 5cc
560006B	O-Ring "Buna" for cartridge 55cc/30cc
560038B	O-Ring "Buna" for cartridge 3cc
560043B	O-Ring "Buna" for cartridge 10cc

O-Ring "Viton"



for aggressive liquids

PU = 10 pieces

dpvlink 2887

Article Type

560005V	O-Ring "Viton" for cartridge 5cc
560006V	O-Ring "Viton" for cartridge 55cc/30cc
560038V	O-Ring "Viton" for cartridge 3cc
560043V	O-Ring "Viton" for cartridge 10cc

Needle cap



PU = 10 pieces

dpvlink 2897

Article Color Thread

580142	clear	no
580142-WT	white	yes
580142-BLK	black	yes

Filter / hose clamps



PU = 1 piece

dpvlink 2905

Article Type

560034	Filter universal
580175	Hose clamp, preformed (metal)
580175R	Hose clamp, round (metal)
560755	Hose clamp, plastic EFD type
580035.42	Device plug replacement for tube 4/2
580035.64	Device plug replacement for tube 6/4

Dispensing needles

Dispensing needle standard (with thread)



With plastic body, capillary tube made of stainless steel, length 6.35 mm (1/4"), PU = 50 pieces

dpvlink 8635

Article Size Color Internal Ø L [mm]

Dispensing needle standard (with thread)				
F560087-0.25	18	green	0.84 mm	6.35
F560088-0.25	20	rose	0.58 mm	6.35
F560089-0.25	21	purple	0.51 mm	6.35
F560090-0.25	22	blue	0.41 mm	6.35
F560014-0.25	23	orange	0.33 mm	6.35
F560015-0.25	25	red	0.25 mm	6.35
F561020-0.25	27	transparent	0.20 mm	6.35
F560016-0.25	30	lavender	0.15 mm	6.35
F561387-0.25	32	yellow	0.11 mm	6.35

Dispensing needle standard (with thread)



with plastic body, capillary tube made of stainless steel, length 12.5 mm (1/2"), PU = 50 pieces

dpvlink 8645

Article Size Color Internal Ø L [mm]

Dispensing needle standard (with thread)				
F560085	14	olive	1.60 mm	12.5
F560086	15	amber	1.37 mm	12.5
F560087	18	green	0.84 mm	12.5
F560088	20	rose	0.58 mm	12.5
F560089	21	purple	0.51 mm	12.5
F560090	22	blue	0.41 mm	12.5

dpvlink 8645

Article Size Color Internal Ø L [mm]

Dispensing needle standard (with thread)				
F560014	25	orange	0.33 mm	12.5
F560015	25	red	0.25 mm	12.5
F561020	27	clear	0.20 mm	12.5
F560016	30	lavender	0.15 mm	12.5

Dispensing needle standard (with thread)



With plastic body, capillary tube made of stainless steel, length 25.4 mm (1"), PU = 50 pieces

dpvlink 8656

Article Size Color Internal Ø L [mm]

Dispensing needle standard (with thread)				
F560085-1	14	olive	1.60 mm	25.4
F560086-1	15	amber	1.37 mm	25.4
F560087-1	18	green	0.84 mm	25.4
F560088-1	20	rose	0.58 mm	25.4
F560089-1	21	purple	0.51 mm	25.4
F560090-1	22	blue	0.41 mm	25.4
F560014-1	23	orange	0.33 mm	25.4
F560015-1	25	red	0.25 mm	25.4
F561020-1	27	clear	0.20 mm	25.4
F560016-1	30	lavender	0.15 mm	25.4

Dispensing needle standard (with thread)



with plastic body, capillary tube made of stainless steel, length 38 mm (1.5"), PU = 50 pieces

dpvlink 8667

Article Size Color Internal Ø L [mm]

Dispensing needle standard (with thread)				
F560085-1.5	14	olive	1.60 mm	38.0
F560086-1.5	15	amber	1.37 mm	38.0
F560087-1.5	18	green	0.84 mm	38.0
F560088-1.5	20	rose	0.58 mm	38.0
F560089-1.5	21	purple	0.51 mm	38.0
F560090-1.5	22	blue	0.41 mm	38.0
F560014-1.5	23	orange	0.33 mm	38.0
F560015-1.5	25	red	0.25 mm	38.0
F561020-1.5	27	clear	0.20 mm	38.0
F560016-1.5	30	lavender	0.15 mm	38.0

Dispensing needle tapered (with thread)



Material PP, length 31.5 mm (1.25") PU = 50 pieces

dpvlink 2963

Article Size Color Internal Ø L [mm]

Dispensing needle tapered (with thread)				
560783	14	orange	1.60 mm	31.5
560010	16	grey	1.20 mm	31.5
560011	18	green	0.84 mm	31.5
560012	20	rose	0.58 mm	31.5
560013	22	blue	0.41 mm	31.5

Dispensing needle flexible (with thread)



Material PP, length 12.5 mm (1/2") / 38.0 mm (1.5") PU = 50 pieces

dpvlink 2969

Article Size Color Internal Ø L [mm]

Dispensing needle flexible (with thread)				
560103-0.5	15	amber	1.24 mm	12.5
560104-0.5	18	green	0.81 mm	12.5
560105-0.5	20	rose	0.58 mm	12.5
560106-0.5	25	red	0.36 mm	12.5
560103	15	amber	1.24 mm	38.0
560104	18	green	0.81 mm	38.0
560105	20	rose	0.58 mm	38.0
560106	25	red	0.26 mm	38.0

Dispensing needle standard 45° (with thread)



angled by 45°, capillary tube made of stainless steel, with plastic body, length 12.5 mm (1/2"), PU = 50 pieces

dpvlink 8678



Article	Size	Color	Internal Ø	L [mm]
Dispensing needle standard 45° (with thread)				
F560016-45	30	lavender	0.15 mm	12.5
F561020-45	27	clear	0.20 mm	12.5
F560015-45	25	red	0.25 mm	12.5
F560014-45	23	orange	0.33 mm	12.5
F560090-45	22	blue	0.41 mm	12.5
F560089-45	21	purple	0.51 mm	12.5
F560088-45	20	rose	0.58 mm	12.5
F560087-45	18	green	0.84 mm	12.5
F560086-45	15	amber	1.37 mm	12.5
F560085-45	14	olive	1.60 mm	12.5

Dispensing needle standard 45° (with thread)



angled by 45°, capillary tube made of stainless steel, with plastic body, length 38 mm (1.5"), PU = 50 pieces

dpvlink 8689



Article	Size	Color	Internal Ø	L [mm]
Dispensing needle standard 45° (with thread)				
F560087-45-1.5	18	green	0.84 mm	38.0
F560085-45-1.5	14	olive	1.60 mm	38.0

Dispensing needle standard 90° (with thread)



angled by 90°, with plastic body, capillary tube made of stainless steel length 12.5 mm (0.5") PU = 50 pieces

dpvlink 8693



Article	Size	Color	Internal Ø	L [mm]
Dispensing needle standard 90° (with thread)				
F560016-90	30	lavender	0.15 mm	12.5
F561020-90	27	clear	0.20 mm	12.5
F560015-90	25	red	0.25 mm	12.5
F560014-90	23	orange	0.33 mm	12.5
F560090-90	22	blue	0.41 mm	12.5
F560089-90	21	purple	0.51 mm	12.5
F560088-90	20	rose	0.58 mm	12.5
F560087-90	18	green	0.84 mm	12.5
F560086-90	15	amber	1.37 mm	12.5
F560085-90	14	olive	1.60 mm	12.5

Dispensing brush



PU = 1 piece

dpvlink 8709



Article	Hardness
561088	hard
561087	soft

Dispensing needle standard (without thread)



With plastic body, capillary tube made of stainless steel, length 12.5 mm (1/2"), PU = 50 pieces

dpvlink 2913



Article	Size	Color	Internal Ø	L [mm]
Dispensing needle standard (without thread)				
560090	22	blue	0.41 mm	12.5
560014	23	orange	0.33 mm	12.5
560964	26	beige	0.22 mm	12.5
560016	30	lavender	0.15 mm	12.5

Dispensing needle standard (without thread)



with plastic body, capillary tube made of stainless steel length 25.4 mm (1") PU = 50 pieces

dpvlink 2915



Article	Size	Color	Internal Ø	L [mm]
Dispensing needle standard (without thread)				
560088-1.0	20	rose	0.58 mm	25.4
560090-1.0	22	blue	0.41 mm	25.4

Dispensing needle assortment



Different standard and tapered dispensing needles in a plastic box

dpvlink 2979



Article	Type
990062.K	Dispensing needle assortment small 17-piece
990062.B	Dispensing needle assortment large 125-piece

Dispensing equipment Kahnetics

Dispenser KDS834A standard

Kahnetics®



Dispenser KDS834A standard

- Supply voltage: 230V/120V
- Dispensing time adjustable between 0.01-99.99 seconds
- no dripping due to vacuum equipment
- electrical foot switch

dpvlink 13504



Article	Type
531.656.99	Dispenser KDS834A standard Dispensing time adjustable 0.01... 99.99 sec, with electrical foot switch, no dripping due to vacuum equipment

Foot valve KDS806V



Foot valve KDS806V

- Simple on / off function
- Foot control for an excellent handling
- Compressed air operation - no power supply required
- Pressure regulator (0-7 bar) and display
- No dripping due to vacuum equipment

dpvlink 13505

Article Type

KDS806V **Foot valve KDS806V**
Pressure regulator and display 0-7 bar, no dripping due to vacuum equipment



KDS301 vacuum pipette



KDS301 vacuum pipette

- Compatible to the dispensing devices KDS824A and KDS834A
- Can be connected to a compressed air hose with a 4 mm diameter via a pressure reducer
- A finger switch on the pipette allows an easy gripping of small components
- Conductive rubber suction cups in three sizes KDS260S (3.2 mm), KDS260M (6.3 mm) and KDS260L (9.5 mm) included in the scope of delivery

dpvlink 13506

Article Type

KDS301 **KDS301 vacuum pipette**
Connection to KDS824A/KDS834A; for compressed air hose with a 4 mm external diameter



Consumables Kahnetics

Kahnetics metal adapter sets



Metal cartridge adapter with 2 m compressed air hose and plug connection can be used for all customary cartridges. Can be connected to any dispenser.

dpvlink 13513

Article Type

KDS810S6 **Metal adapter set KDS810S6; size: 10CC**
Hose diameter: Ø 2.4 mm

KDS830S6 **Metal adapter set KDS830S6; size: 30CC**
Hose diameter: Ø 2.4 mm



Kahnetics cartridge holder KDS816



- Compatible with all sizes of syringes and adapters
- Holds syringe upright - prevention of accidents
- Keeps workbench neat and clean

dpvlink 13520

Article Type

KDS816 **Cartridge holder KDS816**



Spare parts for Kahnetics

dpvlink 13549

Article Type

KDS825 **Device connection socket**
Spare part

KDS900 **Plug for cartridge adapter**
Spare part, PU = 5 pieces

KDS901 **Plug-in coupling for KDS301**
Spare part

KDS260S **Suction insert; small Ø 3.2 mm**
for KDS301 replacement

KDS260M **Suction insert; medium Ø 6.3 mm**
for KDS301 replacement



Dispensing needles Kahnetics

Kahnetics dispensing needles



Stainless steel needles with plastic body
PU = 50 pieces

dpvlink 13522

Article Size Color Internal Ø L [mm]

KDS1412P	14	dark green	1.70 mm	12.7
KDS141P	14	dark green	1.70 mm	25.4
KDS1512P	15	orange	1.52 mm	12.7
KDS1612P	16	purple	1.35 mm	12.7
KDS161P	16	purple	1.35 mm	25.4
KDS16112P	16	purple	1.35 mm	38.1
KDS1712P	17	white	1.14 mm	12.7
KDS1812P	18	rose	0.97 mm	12.7
KDS181P	18	rose	0.97 mm	25.4
KDS1912P	19	brown	0.81 mm	12.7
KDS191P	19	brown	0.81 mm	25.4
KDS2012P	20	yellow	0.66 mm	12.7
KDS201P	20	yellow	0.66 mm	25.4
KDS2112P	21	green	0.58 mm	12.7
KDS2212P	22	black	0.48 mm	12.7
KDS221P	22	black	0.48 mm	25.4
KDS2312P	23	light blue	0.43 mm	12.7
KDS2512P	25	blue	0.30 mm	12.7
KDS3012P	30	lavender	0.15 mm	12.7
KDS660	different	-	-	multiple



Kahnetics dispensing needles



Plastic needles with tapered tip
PU = 50 pieces

dpvlink 13543

Article Size Color Internal Ø

KDS14TNP	15	salmon	1.60 mm
KDS16TNP	16	grey	1.22 mm
KDS18TNP	18	green	0.86 mm
KDS20TNP	20	rose	0.61 mm
KDS22TNP	22	blue	0.43 mm



Workstation lighting

Workstation lighting

LED universal light TANEOSTZL 24

NEU Waldmann **W** 



LED universal light with CDP and stepless dimming.

Swivel arm/frame length 384/400 mm
1300 Lumen

dpvlink 17461



Article	Type
704.STZL24R	LED universal light TANEOSTZL 24R, color aluminum anodized/black incl. 24 Watt LED module 4,000 K, 1300 Lumen
704.TND-1400/950	LED universal light TND 1400/950/D, color aluminum anodized/black incl. 23 Watt LED module 5,000 K, 1500 lumen
704.TND-1400/940-ESD	LED universal light TANEOSTZL 24R, color black incl. 23 Watt LED module 3,900 K, 1350 lumen
704.TND-1400/950-ESD	LED universal light TANEOSTZL 24R, color black incl. 23 Watt LED module 4,900 K, 1350 lumen

Workstation lamp DAYLIGHT Lumi LED



Lumi™ is a professional workstation lamp allowing you to see fine details and true colors. Ideal for the use at any workstation, desk, editing table, drawing table etc. The large shade can be adjusted vertically, horizontally and laterally to any position.

- with spring joint arm 1080 mm
- clamping
- 3.800 Lux (15 Watt)
- 2-stage dimmer
- 1320 Lumen

dpvlink 21117



Article	Type
702.E35500	Workstation lamp DAYLIGHT Lumi LED incl. table clamp, color: white
Accessories	
702.D53060	Floor stand with star base 5 castors, for Ultra Slim and Deluxe



Workstation lamp DAYLIGHT™ Luminos LED



High-performance, suitable for the illumination of large areas at the workstation

- durable precision mechanic of the joints
- effortless handling of the lamp head and the arm with one hand
- 65 cm wide lamp head
- 120 Daylight LEDs
- 3-step dimmer
- pivotable up to 112 cm
- 1566 Lumen

dpvlink 19249

Article	Type
---------	------

702.E35600	Workstation lamp DAYLIGHT™ Luminos LED incl. table clamp Color: grey/white
------------	---



Accessories

702.D53060	Floor stand with star base 5 castors, for Ultra Slim and Deluxe
------------	---



Workstation lamp FL-LED T105



FL-LED T105 is a symmetric workstation lamp used in workshops and on other large working surfaces where a lot of light is required. It can be adjusted individually and easily.

dpvlink 14935

Article	Type
---------	------

700.402	Workstation lamp FL-LED T105 Individually and easily adjustable, symmetric, bright, arm length 105 cm, 12W, 230V.
---------	---



Accessories

700.126	Table mounting socket E, chrome (up to 45 mm)
---------	--



700.127	Mounting bracket CC light grey
---------	---------------------------------------



700.127-W	Mounting bracket CC white
-----------	----------------------------------



700.129	Stand with castors
---------	---------------------------



Lighting NaturLite LED



Natural workstation lighting for industrial environments

Good, adjustable workstation lighting is essential for high work quality and the well-being of employees. The right amount of light at the right time also increases productivity and reduces errors in industrial environments.

Treston Naturlite LED is a natural workstation lighting solution providing individual controllability to industrial environments.

Achieve your full potential with:

- adjustable color shade
- adjustable brightness
- effective performance

Workstation light NaturLite LED Wing 500

TRESTON



The Treston NaturLite LED Wing 500 is a perfect sidelight solution providing a working area with or without shadows depending on the requirements of the currently performed task.

- color temperature 4000 K
- touch dimmer switch for on/off and dimming in the luminaire housing
- suitable for all workbenches of series TP, WB and Concept

dpvlink 21602

Article Type

TNL500W **Workstation light NaturLite LED Wing 500**
430 x 120 x 50 mm (WxDxH) (+ fixation 95/120 mm)



Workstation light NaturLite LED 900

TRESTON



The Treston NaturLite LED 900 fulfills all requirements of a high-quality industrial workstation lighting.

- color temperature 4000 K
- touch dimmer switch for on/off and dimming in the luminaire housing
- suitable for all workbenches of series TP, WB and Concept

dpvlink 21598

Article Type

TNL900 **Workstation light NaturLite LED 900**
900 x 120 x 50 mm (WxDxH)



Workstation light NaturLite LED 1200

TRESTON



The Treston NaturLite LED 1200 fulfills all requirements of a high-quality industrial workstation lighting.

- color temperature 4000 K
- one-touch dimmer switch for on/off and dimming in the luminaire housing
- suitable for all workbenches of series TP, WB and Concept

dpvlink 21596

Article Type

TNL1200 **Workstation light NaturLite LED 1200**
1180 x 120 x 50 mm (WxDxH)



Workstation light NaturLite LED Plus 1200

TRESTON



The Treston NaturLite LED Plus 1200 is as natural as artificial light can be. The turnable white allows the color temperature to be adjusted between 2700 K and 6500 K. The light is also dimmable, providing lighting that suits each individual person and the task in hand.

- turnable white: 2700 K - 6500 K
- control via mobile app or separate remote control
- suitable for all workbenches of series TP, WB and Concept

dpvlink 21600

Article Type

TNL1200P **Workstation light NaturLite LED Plus 1200**
1180 x 120 x 50 mm (WxDxH)



Accessories

TNLPR Remote control for NaturLite LED Plus 1200P

Lighting IntoLite

Workstation lamp IntoLite LED

TRESTON



Treston LED workstation lamp TIL850 assures optimal light of good quality and has the basic features for an optimal illumination of the workstation.

A good and adjustable workstation lighting is of vital importance for the work quality and the well-being of the employees. The right amount of light at the right time also increases the productivity and reduces the risk of errors in industrial environment.s

- color temperature 4000 K
- LED service life 50,000 hours
- illumination of 1800 Lux (lumen per square meter)
- suitable for all work benches of the series TP, WB and Concept

dpvlink 23995

Article	Type
---------	------

TIL850	Workstation lamp IntoLite LED 850 x 67 x 80 mm (WxDxH)
--------	--



System workstation lamps

At system workstations a special lighting is required. The modular design is typical. Depending on the type and the structure of the workstation, the light models can be used either individually or in combination. There are various possibilities to mount and fix them.

Compact fluorescent lamps spread a bright, even light onto the working surface and reduce the power consumption. Disturbing dark zones are avoided. The functional industrial design of the lamps harmonizes perfectly with the styling of modern system workstations.

TAMETO SAH

Waldmann **W**

System workstation light with conical prismatic screen CDP



dpvlink 17440

Article	Type
---------	------

704.SAHQ44	LED system light TAMETO SAHQ 44 color aluminum anodized/black 656 x 187 mm, incl. 18 Watt LED-module, 1450 Lumen
------------	--

704.SAHQ66	LED system light TAMETO SAHQ 66 color aluminum anodized/black 956 x 187 mm, incl. 26 Watt LED-module, 2150 Lumen
------------	--

704.SAHQ88	LED system light TAMETO SAHQ 88 color aluminum anodized/black 1256 x 187 mm, incl. 33 Watt LED-module, 2900 Lumen
------------	---



TAMETO SAHZ

Waldmann **W**

System workstation light with drawbar and conical prismatic screen CDP



dpvlink 17447

Article	Type
---------	------

704.SAHZQ66	LED system light TAMETO SAHZQ 66 color aluminum anodized/black 956 x 187 mm, incl. 26 Watt LED-module, 2150 Lumen
-------------	---



Magnifier lamps

Magnifier lamp LED MAGNIFYING **NEU**  



The LE-WUVE5D lamp has unique illumination options allowing the user to use UV LEDs or standard white. The UV LED lamps work with 400 nm and can be used to inspect protective paint, holograms etc. (for every type of material fluorescing during inspection). This model has more than 48 adjustable white LEDs as well as 30 UV LEDs. It is equipped with an ESD-safe coating providing dissipation of static energy to protect sensitive components.



- 19 x 15.7 cm quality glass lens
- magnifying lens with 5 diopters (2.25X)
- 2-in-1 light source: powerful **daylight LEDs** (6500 K) and **UV LEDs** (400 nm) - **commutable**
- change between UV LED and White LED with switch
- adjustable brightness levels
- color black

dpvlink 26465

Article	Type
I-LE-UVWE5D	LED Magnifier lamp MAGNIFYING



Magnifier lamp LFM

Visi-n **LUXXO**









The versatility and robust construction of the LFM is recognized worldwide. It combines high requirements with a functional design and leads to a long service life and a high customer satisfaction.

dpvlink 3030



Article	Type
700.190	Magnifier lamp LFM LED G2 3 diopters with standard lens 3 diopters = x1.75; Ø 127 mm, spring joint arm 1143 mm/clamping, incl. 9 W LED modules, dimmable, color: light grey
700.191	Magnifier lamp LFM LED G2 5 diopters with standard lens 5 diopters = x2.25; Ø 127 mm, spring joint arm 1143 mm / fixing clamp, incl. 9 W LED module, dimmable, color: light grey
700.190.W	Magnifier lamp LFM LED G2 3 diopters with standard lens 3 diopters = x 1.75; Ø 127 mm, spring joint arm 1143 mm / fixing clamp, incl. 9 W LED module, dimmable, color: white
700.191.W	Magnifier lamp LFM LED G2 5 diopters with standard lens 5 diopters = x 2.25; Ø 127 mm, spring joint arm 1143 mm / fixing clamp, incl. 9 W LED module, dimmable, color: white

Accessories

	700.246	Additional lens 6 diopters Ø 35 mm
	700.244	Additional lens 4 diopters Ø 35 mm
	700.128.AH.GR	AH fixing clamp color: light grey, clamping width 60 mm
	700.205	Ring fluorescent tube 22 Watt
	700.126	Table mounting socket E, chrome (up to 45 mm)
	700.127	Mounting bracket CC light grey
	700.129	Stand with castors

Magnifier lamp KFM-LED



KFM LED impresses with a robust full-metal construction in elegant design, a flexible arm and an excellent lighting performance. The quality and the exact positioning of the LEDs ensures a nearly shadow-free magnification and excellent presentation of colors.

dpvlink 17403



Article	Type
700.240.ESD	Magnifier lamp KFM-LED ESD with glass lens 3 diopters = x1.75; color ESD black
700.241.ESD	Magnifier lamp KFM-LED ESD with glass lens 5 diopters =x2.25; color ESD black
700.240	Magnifier lamp KFM-LED with glass lens 3 diopters = x1.75; color light grey
700.241	Magnifier lamp KFM-LED with glass lens 5 diopters =x2.25; color light grey

Accessories

	700.128.AH.GR AH fixing clamp color: light grey, clamping width 60 mm
	700.244 Additional lens 4 diopters Ø 35 mm
	700.246 Additional lens 6 diopters Ø 35 mm
	700.247 Additional lens 10 diopters Ø 35 mm
	700.126 Table mounting socket E, chrome (up to 45 mm)
	700.127-S Mounting bracket CC black
	700.127 Mounting bracket CC light grey
	700.129 Stand with castors

Magnifier lamp W.A.V.E. LED



The Wave LED is an illuminated magnifier for industrial applications, with 2 x 6 Watt LED light sources and a flexible self-balancing arm. It offers shadow-free magnification with light coming from both sides, as well as three-dimensional magnification with light coming from the left or right.

- spring-loaded arm / clamp fastening AH
- total extension 1050 mm
- including 2 x 6 Watt LED module

dpvlink 17307



Article	Type
700.141.ESD	Magnifier lamp W.A.V.E. LED / ESD glass lens, 3.5 diopters = x 1.88, color black ESD
700.141.ESD.UV	Magnifier lamp W.A.V.E. LED / ESD UV with UV-A LED light, glass lens, 3.5 diopters = x 1.88, color black ESD
700.141	Magnifier lamp W.A.V.E. LED standard lens, 3.5 diopters = x 1.88, color light grey,
700.141.UV	Magnifier lamp W.A.V.E. LED UV with UV-A LED light, standard lens, 3.5 diopters = x 1.88, color light grey
700.142.ESD	Magnifier lamp W.A.V.E. LED / ESD glass lens, 5 diopters = x 2.25, color black ESD
700.142.ESD.UV	Magnifier lamp W.A.V.E. LED / ESD UV with UV-A LED light, glass lens, 5 diopters = x 2.25, color black ESD
700.142	Magnifier lamp W.A.V.E. LED standard lens, 5 diopters = x 2.25, color light grey,
700.142.UV	Magnifier lamp W.A.V.E. LED UV with UV-A LED light, standard lens, 5 diopters = x 2.25, color light grey

Accessories

	700.128.AH.GR AH fixing clamp color: light grey, clamping width 60 mm
	700.244 Additional lens 4 diopters Ø 35 mm
	700.246 Additional lens 6 diopters Ø 35 mm
	700.247 Additional lens 10 diopters Ø 35 mm
	700.126 Table mounting socket E, chrome (up to 45 mm)
	700.127 Mounting bracket CC light grey
	700.127-S Mounting bracket CC black

Magnifier lamp CIRCUS

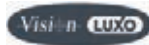



The lamp CIRCUS is ideal for beauty salons, hospitals and laboratories as well as for people with visual impairments. The diameter of the lens is 165 mm, the light has a patented spring arm and a highly flexible head joint, for a horizontal, vertical and lateral positioning.

dpvlink 6341

Article	Type
700.352	Magnifier lamp CIRCUS LED 3.5 diopters with standard lens, 3.5 diopters = x 1.88, Ø 165 mm, parallel joint arm 1000 mm / fixing clamp, incl. 10 Watt LED, dimmable color white / cover black
700.353	Magnifier lamp CIRCUS LED 5 diopters with standard lens, 5 diopters = x 2.25, Ø 165 mm, parallel joint arm 1000 mm / fixing clamp, incl. 10 Watt LED, dimmable color white / cover black

Accessories

	700.128.AH.GR AH fixing clamp color: light grey, clamping width 60 mm
	700.355 Ring fluorescent tube 22 Watt / T-5C
	700.126 Table mounting socket E, chrome (up to 45 mm)
	700.127 Mounting bracket CC light grey
	700.129 Stand with castors

Magnifier lamp DAYLIGHT iQ ESD



The iQ ESD™ is a completely ESD-safe magnifier lamp certified for the use in electrostatically protected areas according to IEC 61340-5-1 and ANSI/ESD 20:20. The 2-in-1 lamp has powerful daylight LEDs (6.000 K) for a clear, shadow-free illumination as well as UV-A LEDs (365 nm) for the inspection of protective coatings and a careful control of solder joints, welding joints and other areas with mechanical load. With two brightness levels for different tasks, a stable positioning and a 17.5 cm lens the iQ ESD™ is the ultimate ESD-safe 2-in-1 magnifier lamp.



- 17.5 cm high-quality glass lens (low iron)
- magnifying lens with 3 diopters (1.75x) and additional swinging arm lens with 12 diopters (4x)
- particularly strong and durable carbon fiber head and joint keep any position
- 2-in-1 light source: powerful **daylight LEDs** (6,000K) and **UV-A LEDs** (365 nm) - **switchable**

- brightness levels for adapting the light to your respective task
- large reach of 118 cm
- additional swinging arm lens with 12 diopters (x4)
- black

dpvlink 25440

Article	Type
702.E25101-ESD	LED magnifier lamp iQ ESD

Accessories

	702.D53060 Floor stand with star base 5 castors, for Ultra Slim and Deluxe
---	--

Magnifier lamp DAYLIGHT MAG Lamp S



MAG-Lamp S is a magnifier lamp with a modern and slim design. It has 2 brightness levels and a glass lens having a diameter of 12.7 cm. The adjustable spring arm can be positioned easily and precisely.

- magnification: x1.75 (3 diopters)
- high-performance LEDs
- dimmable (2 stages)

dpvlink 21311

Article	Type
702.EN1200	Magnifier lamp DAYLIGHT MAG Lamp S incl. table clamp, color: white



LED Magnifier lamp "Ultra-Slim XR - LED"



LED magnifying lamp "Ultra-Slim XR-LED" standard glass lens 175 mm / 3 diopters (x1.75); with spring joint arm 950 mm / clamp fixing; color: grey/white; incl. 12 Watt LED module (dimmable)

dpvlink 17911

Article	Type
702.E25100	LED Magnifier lamp "Ultra-Slim XR - LED"



Accessories

702.D53060 **Floor stand with star base**
5 castors, for Ultra Slim and Deluxe

702.D62001 **Additional lens Ultra Slim XR**
5 diopters / x2.25 magnification



LED magnifier lamp Omega



Omega 5 Art. 702.E25110

State-of-the-art and ergonomic LED magnifier lamp



Omega 7 Art. 702.E25130

- LED
- luminous color 6000°K
- color: white/light grey
- Quick-Lens-Swap lens changing system - no tools required
- clamping
- robust arm with reinforced joints
- freely and easily movable head and arm with stable positioning

dpvlink 21451

Article	Type
702.E25110	LED magnifier lamp Omega 5 2 standard glass lenses 127 mm / 3 diopters (x1.75) and 5 diopters (x2.25) , LED module 8 Watt, four brightness levels
702.E25130	LED magnifier lamp Omega 7 Acrylic lens 175 mm / 3 diopters (x1.75) , LED module 12 Watt, two brightness levels



Accessories

702.D53060 **Floor stand with star base**
5 castors, for Ultra Slim and Deluxe



Magnifier lamp TEVISIO TVD

Waldmann **W** 



The magnifier lamp TEVISIO fulfills the highest requirements in terms of mobility and quality of vision. In every application field it supports the most demanding visual tasks with ergonomic perfection and due to its advanced LED technology, innovative arm technology and a field of view optimally adapted to the eye distance.



- LED technology
- Power consumption 14 W
- Color temperature neutral white 4.000 K
- Light control by reflector
- Glass lens Ø 160 mm mit 3.5 diopters (optionally with fixed additional lens 8 diopters - except ESD versions)
- Housing made of natural anodized aluminium and black high-performance plastic, satined acrylic screen

- 3D head joint for individual adjustments
- Spring-balanced arm
- Membrane key with lamp button for on/off, dimming and optional segment switching
- Protection class IP 20, protection class 2
- Power supply unit, 100 - 240 V, 50/60 Hz, 3.8 m connection cable
- steplessly dimmable



Optional segment switching: three options to switch the light segments in order to generate structured effects.

dpvlink 16139



Article	Type
703.162.ESD	ESD magnifier lamp TEVISIO RLLQ 48/2AR-ESD 3.5 diopters segment switching Articulated arm 484 / 500 mm ESD version
703.164.ESD	ESD magnifier lamp TEVISIO RLLQ 48 2R 3.5 diopters segment switching Articulated arm 384 / 400 mm ESD version
703.160	LED Magnifier lamp TEVISIO TVD 750/940/DM / 3.5 Dio 3.5 diopters Articulated arm with 3D head joint 484 / 500 mm
703.161	LED Magnifier lamp TEVISIO TVD 750/940/DM / 3.5 Dio +ZL8 3.5 diopters + fixed additional lens 8 diopters Articulated arm with 3D head joint 484 / 500 mm
703.164	LED Magnifier lamp TEVISIO TVD 750/940/DM / 3.5 Dio 3.5 diopters Articulated arm 384 / 400 mm with 3D head joint
703.165	LED Magnifier lamp TEVISIO TVD 750/940/DM / 3.5 Dio +ZL8 3.5 diopters + fixed additional lens 8 diopters Articulated arm with 3D head joint 384 / 400 mm

!!! Table clamp not included in the scope of delivery !!!

Accessories

	703.900 Table clamp TK 1 / 65, 0-65 mm suitable for all Waldmann magnifier lamps
	703.900.ESD Table clamp TK 1/65-ESD, 0-65 mm suitable for all Waldmann magnifier lamps
	703.905 Wall mounting bracket

Ring LED magnifier lamp RLLQ 63

Waldmann **W**



- High illuminance intensity and high energy-saving potential due to an extremely efficient LED lighting concept
- Extremely long service life of the lamp by LED technology and thus minimal maintenance costs
- Distortion-free presentation of the object to be tested by a high-quality plastic lens (6 diopters)
- Simple switching the lamp on and off with an integrated soft-touch sensor on the head
- Magnifier lamp can withstand any strain
- Lamp impresses due to its timeless industrial design and minimal height (12 mm)

dpvlink 13693



Article	Type
703.150	Ring LED magnifier lamp RLLQ 63 6 W; 100-240 V, 50-60 Hz; IP 20 with base

!!! Table clamp not included in the scope of delivery !!!

Accessories

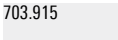
	703.900 Table clamp TK 1 / 65, 0-65 mm suitable for all Waldmann magnifier lamps
	703.915 Table base, black for ring LED magnifier lamp RLLQ 6

Magnifier lamp SNLQ 54/2 A

Waldmann **W** 



With the magnifier lamp SNLQ 54/2 A it is possible to modify basically the lighting character by switching the LED. This allows to execute all inspections with only one lamp.

dpvlink 19988

Article	Type
703.122	Magnifier lamp SNLQ 54/2 A with standard lens 3 diopters = x 1.75 , 162 x 105 mm, spring-loaded arm / screw-down flange, Ra > 95 incl. 12 Watt LED, light grey
703.122.ESD	Magnifier lamp SNLQ 54/2 A ESD ESD version, black



Accessories

703.130 **Attachable lens 4 diopters 100 x 50 mm**
for FLG 118, SNL 319, SNLQ



703.900 **Table clamp TK 1 / 65, 0-65 mm**
suitable for all Waldmann magnifier lamps



703.900.ESD **Table clamp TK 1/65-ESD, 0-65 mm**
suitable for all Waldmann magnifier lamps



703.901 **Table clamp TK 1 / 135, 65-135 mm**



VarioLED magnifier lamp

ESCHENBACH



- magnifier lamp for shadow- and flicker-free working
- ring light with 84 long-lasting high-performance LEDs
- illuminance adjustable in three steps with push-button
- swivel range of the magnifier head 180°
- cable length 3m
- plastic lens 132 mm with foldable cover
- delivery including table clamp for plates with a thickness of 18-74 mm

dpvlink 22908

Article	Type
ES-27773	VarioLED magnifier lamp 1.9x magnification with plastic lens 3.55 diopters = 1.9x
ES-27776	VarioLED magnifier lamp 2.5x magnification with plastic lens 6 diopters = 2.5x



Eschenbach Stereo microscopes

LED Stereo zoom microscope



- Reflected-light stereo microscope with robust metal tripod
- binocular 45° angled eyepiece, 360° rotation
- wide field eyepieces with 10x magnification
- ocular tube on the left with diopter adjustment from +/- 5 dpt.
- lenses: turning revolver 1x and 2x, parallel
- episcopic LED ring light, dimmable
- plastic support plate



dpvlink 21099

Article	Magnification	Working distance
ES-33213	10x/20x	82-79



Accessories

MONTA00195xP Accessories for ES-33213 and ES33263

LED Stereo zoom microscope with metallic articulated arm



- Reflected-light stereo microscope with robust metallic articulated arm
- binocular 45° angled eyepiece
- 360° rotation
- wide field eyepieces with 10x magnification
- ocular tube on the left with diopter adjustment from +/- 5 dpt.
- lenses: turning revolver 1x and 2x, parallel
- episcopic LED ring light
- dimmable



dpvlink 21101

Article	Magnification	Working distance
ES-33263	10x/20x	82-79



Accessories

MONTA00195xP Accessories for ES-33213 and ES33263

KERN Microscopes

Stereo zoom microscope binocular Kern OZL 465



- stereo zoom microscope
- incident LED ring light and transmitted light
- steplessly dimmable
- binocular 45° angled view
- diopter balance on both sides
- high widefield eyepiece with 10x magnification



dpvlink 24073

Article	Type	Magnification	Working distance
401.OZL465	Stereo zoom microscope binocular Kern OZL 465	0.7x/4.5x	105 mm



dpvlink 24073

Article	Ausführung
401.OZB-A4645	Solder protection lens Kern OZB-A4645 suitable for 401.OZL465, 401.OZL466, 401.OZL961 and 401.OZL963



Stereo zoom microscope trinocular Kern OZL 466



- stereo zoom microscope
- incident LED ring light and transmitted light
- steplessly dimmable
- binocular 45° angled view
- C-Mount adapter for camera required
- diopter balance on both sides
- high widefield eyepiece with 10x magnification

dpvlink 24082

Article	Type	Magnification	Working distance
401.OZL466	Stereo zoom microscope OZL 466 trinocular	0.7x/4.5x	105 mm



dpvlink 24082

Article	Ausführung
401.OZB-A4645	Solder protection lens Kern OZB-A4645 suitable for 401.OZL465, 401.OZL466, 401.OZL961 and 401.OZL963



Article	Ausführung
401.OZB-A4811	C-Mount camera adapter Kern OZB-A4811 suitable for 401.OZL466 and 401.OZL963



Stereo zoom microscope binocular Kern OZL 961 with telescopic arm

- stereo zoom microscope with universal telescopic arm stand
- with plate
- 4.5 Watt incident LED ring light
- steplessly dimmable
- binocular 45° angled view
- diopter balance on both sides
- high widefield eyepiece with 10x magnification



dpvlink 24085

Article	Type	Magnification	Working distance
401.OZL961	Stereo zoom microscope OZL 961 binocular with telescopic arm	0.7x/4.5x	105 mm



dpvlink 24085

Article	Ausführung
---------	------------



401.OZB-A4641 **Ancillary lens 0.5x Kern OZB-A4641** suitable for 401.OZL461 and 401.OZL963



401.OZB-A4645 **Solder protection lens Kern OZB-A4645** suitable for 401.OZL465, 401.OZL466, 401.OZL961 and 401.OZL963



401.OZB-A4643 **Ancillary lens 2.0x Kern OZB-A4643** suitable for 401.OZL461 and 401.OZL963

Stereo zoom microscope trinocular Kern OZL 963 with telescopic arm

- stereo zoom microscope with universal telescopic arm stand
- with plate
- 4.5 Watt incident LED ring light
- steplessly dimmable
- binocular 45° angled view
- C-Mount adapter for camera required
- diopter balance on both sides
- high widefield eyepiece with 10x magnification



dpvlink 24087

Article	Type	Magnification	Working distance
401.OZL963	Stereo zoom microscope OZL 963 trinocular with telescopic arm	0.7x/4.5x	105 mm



dpvlink 24087

Article	Ausführung
---------	------------



401.OZB-A4641 **Ancillary lens 0.5x Kern OZB-A4641** suitable for 401.OZL461 and 401.OZL963



401.OZB-A4645 **Solder protection lens Kern OZB-A4645** suitable for 401.OZL465, 401.OZL466, 401.OZL961 and 401.OZL963



401.OZB-A4643 **Ancillary lens 2.0x Kern OZB-A4643** suitable for 401.OZL461 and 401.OZL963



401.OZB-A4811 **C-Mount camera adapter Kern OZB-A4811** suitable for 401.OZL466 and 401.OZL963

Accessories for KERN stereo zoom microscope

dpvlink 24091

Article	Type
401.OZB-A4811	C-Mount camera adapter Kern OZB-A4811 suitable for 401.OZL466 and 401.OZL963
401.OZB-A4641	Ancillary lens 0.5x Kern OZB-A4641 suitable for 401.OZL461 and 401.OZL963
401.OZB-A4643	Ancillary lens 2.0x Kern OZB-A4643 suitable for 401.OZL461 and 401.OZL963
401.OZB-A4645	Solder protection lens Kern OZB-A4645 suitable for 401.OZL465, 401.OZL466, 401.OZL961 and 401.OZL963



Stereo zoom eyepiece microscope

The binocular SX45 is a high-quality stereo zoom microscope with optical Greenough principle for diverse applications in laboratory, research & routine, quality assurance in the industry, education and training, etc.



High-quality stereo zoom microscope with optical Greenough principle for a wide range of applications impresses by a solid, durable design and its easy operation. The image remains in the exact level of sharpness throughout entire zoom range.

- High-quality components
- Zoom factor 6.3:1
- Magnification x4 - x200 (x20 eyepieces)
- 22 mm eyepieces (field number / field of view) with diopter setting
- Extra long working distance of 220 mm
- LED lighting (6,000 hours LLD)
- Adjustable incident and transmitted light
- Optional sliding table
- Optional LED ring light
- Also available with pillar stand or articulated arm
- Trinocular microscope body for camera connection
- Excellent price-performance ratio
- 110V - 240V

Optical data

Eyepieces	Lenses	Zoom range	Working distance
x10 / 22 F.N.	x0.5	x4 - x25	220.6 mm
x10 / 22 F.N.	x1.0	x8 - x50	115.0 mm
x10 / 22 F.N.	x2.0	x16 - x100	57.5 mm
x20 / 13 F.N.	x0.5	x8 - x50	220.6 mm
x20 / 13 F.N.	x1.0	x16 - x100	115.0 mm
x20 / 13 F.N.	x2.0	x32 - x200	57.5 mm



Table stand, compact and versatile

- Highly flexible mechanism for optimized ergonomics and increased efficiency and productivity.
- Adjustable LED incident light and LED transmitted light.

Articulated arm, for an increased reach

- Designed for applications requiring more freedom of movement and at the same time constant stability.
- Higher flexibility during the inspection of large parts, also suitable for several workstations. Easy mounting with table clamp.

Pillar stand, ideal for large space requirement



- Adjustable and swiveling unit for a direct mounting on the working surface of the user or with base plate.
- Flexible and easy to use.

Accessories

Image documentation & archiving

Trinocular microscope body for camera and video connection. Modular multimedia solutions for recording, measuring, and storing images.



LED ring light

For alternative or additional lighting. (Standard lighting for articulated arm and pillar stand variant)



Sliding table

Only in conjunction with table stand, for small components and parts, ideal for inspection.



Polarization set

Polarizing filter optional for the table stand.

Dimensions

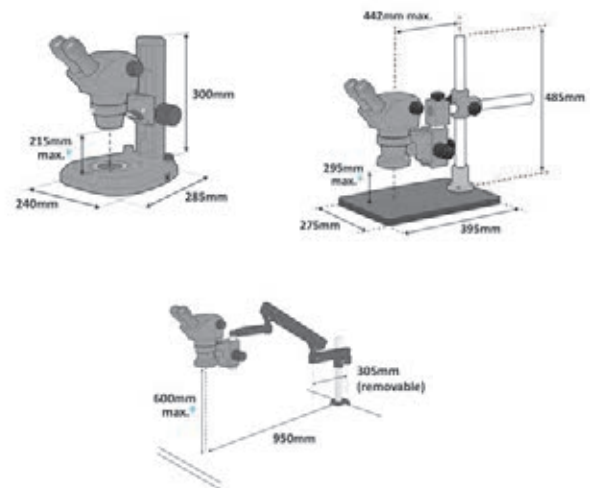

SX45 with table stand

dpvlink 14212

Article Type

- | | |
|------------|---|
| SX45 | <p>SX45 Elite stereo zoom microscope eyepiece
Binocular complete device, consisting of:</p> <ul style="list-style-type: none"> S-201 Binocular stereo head with zoom 6.3:1 click-stop S-203 Table stand with dimmable LED incident & transmitted light S-004 x10 eyepieces (magnification of x8-x50) |
| SX45-TR | <p>SX45 Elite stereo zoom microscope eyepiece
Trinocular complete device, consisting of:</p> <ul style="list-style-type: none"> S-202 Trinocular head (photo output) with zoom 6.3:1 click-stop S-203 Table stand with dimmable LED incident & transmitted light S-004 x10 eyepieces (magnification of x8-x50) |
| SX45-D08.0 | <p>SX45 Elite stereo zoom microscope eyepiece
Complete device with image editing, consisting of:</p> <ul style="list-style-type: none"> S-202 Trinocular head (photo output) with zoom 6.3:1 click-stop S-203 Table stand with dimmable LED incident & transmitted light S-004 x10 eyepieces (magnification of x8-x50) S-012 C-mount adapter for USB 1/2" camera S-PIF08.0 Imaging Kit 8.0, software and 5.2Mpix color camera, dongle |



SX45 with pillar stand



dpvlink 14213



Article	Type
SX45BS	SX45 Elite stereo zoom microscope eyepiece <i>Binocular complete device, consisting of:</i> S-201 Binocular stereo head with zoom 6.3:1 click-stop S-004 x10 eyepieces (magnification of x8-x50) S-206 Pillar stand with base plate S-005 Ring light with dimmable power supply unit
SX45BS-TR	SX45 Elite stereo zoom microscope eyepiece <i>Trinocular complete device, consisting of:</i> S-202 Trinocular head (photo output) with zoom 6.3:1 click-stop S-004 x10 eyepieces (magnification of x8-x50) S-206 Pillar stand with base plate S-005 Ring light with dimmable power supply unit
SX45BS-D08.0	SX45 Elite stereo zoom trinocular microscope <i>Complete device with image editing, consisting of:</i> S-202 trinocular head (photo output) with zoom 6,3:1 click-stop S-004 x10 eyepieces (magnification of x8-x50) S-206 Pillar stand with dimmable LED incident and transmitted light S-005 Ring light with dimmable power supply unit S-012 C-Mount Adapter for USB 1/2" camera PIFO 8.0 Imaging-Kit, software and USB 1/2" color camera (5.2Mpix)

SX45 Accessories



dpvlink 11075



Article	Type
S-201	SX45 Elite Stereo zoom microscope body
S-202	SX45 Elite Trinocular stereo zoom microscope body
S-203	Stand with LED display incident/transmitted light
S-004	x10 eyepieces (pair)
S-005VECE	SX LED ring light with power supply unit dimmable, 4 segment control
S-206	Pillar stand
S-207	Articulated arm with adapter
S-008	Ancillary lens x0.5
S-009	Ancillary lens x2.0
S-010	Eyepiece pair x20/13
S-017	Rubber grommets for eyepieces (pair)
S-015	Replacement for incident light on S-003
S-016	Replacement LEDs for incident light on S-003
S-018	Eyepiece x10 with graticule scale 10 mm/0.1 mm
S-019	Camera adapter C-mount x0.5
S-024	Rubber eyecups for eyepieces (pair)

Inspection systems

MANTIS Inspection systems

The MANTIS product family is a comprehensive range of patented, optical stereo systems without eyepieces for a simple as well as sophisticated control and inspection tasks requiring exceptional ergonomics and visual quality.

MANTIS is successfully used all over the world and has established itself as an industry standard for ergonomic inspection in the lower to the medium-sized magnification range.

With the new generation Mantis offers exacting users a product family with a modern, optical design, the latest material developments and a balanced LED lighting.

The eyepieceless stereo inspection system MANTIS provides a nearly inexhaustible wealth of applications and is particularly suitable for applications in electronics, precision engineering, plastics industry, with medical components, and much more. Furthermore, it can be used directly in production lines, in technical and analytical laboratories, as well as in biomedical sectors.

Special advantages of the new MANTIS generation are:

- Very attractive price-performance ratio
- Compact, functional unit
- Large magnification range (up to x20)
- Shadow-free LED lighting, incident and transmitted light
- Large working distances, large field of view
- Stable system structure

MANTIS Compact

- High benefit at an affordable price
- Magnification x2, x4, x6, x8 by quick-change lenses
- True-color LED lighting with long service life
- 3 tripod variants (universal stand, articulated arm or table stand)
- Large working distances
- Excellent hand-eye coordination for ergonomic working
- Maximum freedom of head movement



Technical data:

Magnification:	real linear 2x, 4x, 6x, 8x magnification
Lens mount:	for 1 lens
Lighting:	20 LEDs / 9,400 LUX
Power supply:	9V DC, external power supply unit
Weight:	5.4 kg net with universal stand 6.6 kg net with table stand 14.0 kg net with articulated arm

Details of the optics

Article	Magnification	Working distance [mm]	Field of view [mm]
MCO-002	x2	167	45.0
MCO-004	x4	96	27.5
MCO-006	x6	73	19.2
MCO-008	x8	59	13.75

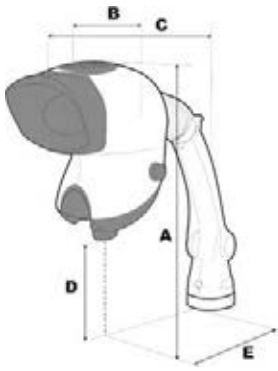

Dimensions with universal stands:

- A = 395 mm - 605 mm
- B = 213 mm
- C = 565 mm - 775 mm
- D = 90 mm - 300 mm
- E = 335 mm - 545 mm

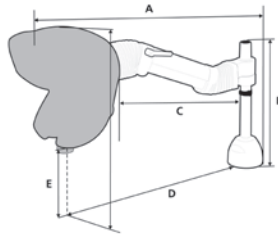

Dimensions with articulated arm:

- A = 880 mm
- W = 430 mm
- C = 510 mm
- D = 650 mm
- E = 290 mm

MANTIS Compact "Flexible"



For general incident light applications with a magnification of x2, x4, x6 or x8, inspection and rework "freehand" on small and large parts from all technical fields, great flexibility by specially designed articulated arm, single-station system with clamping or 3-hole mounting on the workstation.

dpvlink 10973

Article	Type
---------	------

MC-Flex	MANTIS compact "Flexible"
---------	----------------------------------



MANTIS Compact "Universal"



For general incident light applications with magnification x2, x4, x6 or x8, inspection and rework "freehand" on small and large parts from all technical fields, single-station system with clamping or 3-hole mounting on the workstation.

dpvlink 7262

Article	Type
---------	------

MC-Uni	Mantis Compact "Universal" Head MCH 001X (without lens), MCS-005 universal stand, LED incident light, dust cover for table mounting, including power supply unit 100-240V / 50-60 Hz.
--------	---



MANTIS Compact "TS"



For general incident and transmitted light applications for magnification x2, x4, x6 or x8, inspection of small parts (also transparent parts) from all technical fields, single-station system for placing on the workstation.

dpvlink 7264

Article	Type
---------	------

MC-TS	MANTIS Compact "TS" Head MCH 001X (without lens), table stand MBS-002, incident and transmitted light, dust cover, including power supply unit 100-240V / 50-60 Hz.
-------	---



Lenses for MANTIS Compact



dpvlink 7270

Article	Type
---------	------

MCO-002	Lens 2-fold Working distance 167 mm
MCO-004	Lens 4-fold Working distance 96 mm
MCO-006	Lens 6-fold Working distance 73 mm
MCO-008	Lens 8-fold Working distance 59 mm
MCO-010	Protection glasses for lenses 2-/4-/6-/8-fold (4 pcs), for MANTIS Compact



Projection head for MANTIS compact



dpvlink 7294



Article

MCH-001 **Projection head (without lenses)**
LED lighting, suitable for stand MCS 005 /-006 / MEF-001

MCH-002 **UV projection head (without lenses)**
UV LED lighting, suitable for stand MCS 005 /-006

Stands for MANTIS Compact



dpvlink 7288



Article

Type

MCS-005 **Universal stand (swivel arm)**
with position lock

MBS-002 **Table stand**
with fine focusable object slide, transmitted light

MCF-001 **Articulated arm**
with position lock, reach 700 mm

MANTIS Elite

- Excellent optical performance
- Magnification x2 - x20 optional (2-fold lens turret "Quick Change")
- Extra large "exit pupil" for maximum freedom of head movement
- Large field of view
- True-color LED lighting with long service life
- 3 tripod variants (universal stand, articulated arm or table stand)
- Large working distances



Technical data:

Magnification:	real linear magnification 4x, 6x, 8x, 10x, 15x, 20x
Lens turret:	for 2 lenses
Lighting:	24 LEDs / 11,000 LUX
Power supply:	9V DC, external power supply unit
Weight:	6.3 kg net with universal stand 7.5 kg net with table stand 14.5 kg net with articulated arm

Details of the optics

Article	Magnification	Working distance [mm]	Field of view [mm]
MEO-002	x2	160	57.0
MEO-004	x4	96	34.0
MEO-006	x6	68	23.0
MEO-006SL	x6	112	20.0
MEO-008	x8	59	17.0
MEO-010	x10	54	13.5
MEO-015	x15	40	8.8
MEO-020	x20	29	6.5

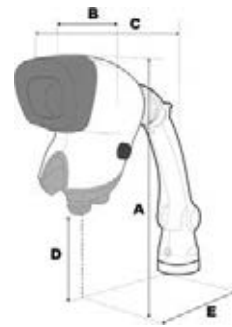

Dimensions with universal stands:

A = 415 mm - 624 mm
B = 212 mm
C = 593 mm - 802 mm
D = 83 mm - 292 mm
E = 352 mm - 622 mm

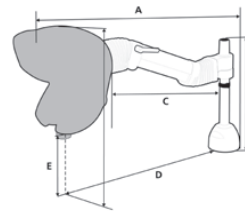

Dimensions with articulated arm:

A = 880 mm
W = 430 mm
C = 510 mm
D = 650 mm
E = 290 mm

MANTIS Elite "Flexible"



For general incident light applications with magnification x2 to x20 (option), inspection and rework "freehand" on small and large parts from all technical fields, great flexibility by specially designed articulated arm, single-station system with clamping or 3-hole mounting on the workstation. For magnifications of x10 and higher the use of the table stand MBS-002 is recommended.

dpvlink 10975



Article

Type

ME-Flex **MANTIS Elite "Flexible"**

MANTIS Elite "Universal"



For general incident light applications with magnification x2 to x20 (option), inspection and rework "freehand" on small and large parts from all technical fields, single-station system with clamping or 3-hole mounting on the workstation. For magnifications of x10 and higher the use of the table stand MBS-002 is recommended.

dpvlink 7266

Article	Type
---------	------

ME-Uni	MANTIS Elite "Universal" Head MEH-001 with turret for 2 magnifications (without lenses), swivel/tilt stand MES-005, incident light, dust cover, power supply unit 100-240V / 50-60 Hz.
--------	--



MANTIS Elite "TS"



For general incident and transmitted light applications for magnification x2 to x20 (option), inspection of small parts (also transparent parts) from all technical fields, single-station system to place on the workstation.

dpvlink 7268

Article	Type
---------	------

ME-TS	MANTIS Elite "TS" Head MEH 001X with turret for 2 magnifications (without lens), table stand MES-006 with fine focus, incident and transmitted light, dust cover, power supply unit 100-240V / 50-60 Hz.
-------	--



Accessories for the MANTIS Compact / Elite



dpvlink 7284

Article	Type
---------	------

MS-002	Sliding table 100 x 100 mm for table stand
MS-003	Dust cover for MANTIS
MEI-001	LED EPI for Mantis Elite Magnification x4



Lenses for MANTIS Elite



dpvlink 7274

Article	Type
---------	------

MEO-002	Lens 2-fold Working distance 160 mm
MEO-004	Lens 4-fold Working distance 96 mm
MEO-006	Lens 6-fold Working distance 68 mm
MEO-006SL	SLWD lens 6-fold Working distance 112 mm
MEO-008	Lens 8-fold Working distance 59 mm
MEO-010	Lens 10-fold Working distance 54 mm
MEO-015	Lens 15-fold Working distance 40 mm
MEO-020	Lens 20-fold Working distance 29 mm
MEO-025	Protection glasses for lenses 4-/8-/10-fold (4 pieces) for MANTIS Elite
MEO-026	Protection glasses for lens 6-fold (4 pieces) for MANTIS Elite
MEO-027	Protection glass for SLWD lens 6-fold 1 piece for MANTIS Elite



MANTIS Elite HD-CAM projection head



Mantis Elite HD-Cam is an advanced version of the successful Mantis stereo inspection system for the recording and documentation of significant images.

The Mantis Elite HD-Cam projection head (without lenses), incl. HD camera with USB port (compatible with stands MBS-002, MES-006, MEF-001 MEFS-001)

- Mantis Elite projection head with factory-integrated USB2.0 camera
- Ideal also for training and educational purposes
- Easy image recording by "1-time-click" on the keyboard
- Storage of image data in: BMP, JPEG & PNG

dpvlink 13737

Article	Type
---------	------

MHD-001	MANTIS Elite CAM projection head
---------	---



Projection head for MANTIS Elite



dpvlink 7296

Article	Type
---------	------

MEH-001	Projection head (without magnifying lenses) LED lighting, suitable for stand MES-005 / MBS-002 / MEF-001
---------	--



Stands for MANTIS Elite



dpvlink 7291

Article	Type
---------	------

MES-005	Universal stand (tilt/swivel arm) with position lock
MEFS-001	Elite floor stand with castors and articulated arm reach: 700 mm
MEF-001	Articulated arm
MF-005	Extension for articulated arm for MEF 001 + MEFS-001 Reach total 500-850 mm



LYNX EVO



LYNX EVO - stereo microscope

The eyepiece-less stereo microscope

- ergonomic top performance improves productivity
- improved optics allows fast and accurate inspection
- flexibility for a wide range of applications

Lynx EVO is an eyepiece-less stereo microscope, powering your productivity by first-class 3D imaging. The unique patented eyepiece-less optics of Lynx EVO allows the user a comfortable working position and thus more efficient working. The user-friendliness and ergonomics of Lynx EVO are unprecedented. The microscope **LynxEVO: more efficient, more accurate, more productive!**



The advantages of Lynx EVO:

- Unique 3D imaging (stereo) - the user can look around the subject from a 34° angle (improved 3D view/depth perception)
- a natural view of the subject - ambient light falls into the eyes, as the user may sit back from the eyepiece
- suitable for eyeglasses - due to the eyepiece-less optics users do not need to remove their glasses (or safety glasses)
- protection against cross-infection and sample contamination - as there is no direct contact between user and eyepiece/front lens
- ergonomic working position - much more comfortable and less fatiguing working
- freedom of head movement - providing the user radial and axial freedom of head movement when working
- Excellent hand-eye coordination - sitting back from the viewing lens allows the user much better peripheral vision

Technische Daten



360° rotating optics - the 360° rotation provides a better detail inspection. The viewing angle from the vertical is 34° - permitting the user to see clearly even hidden details.

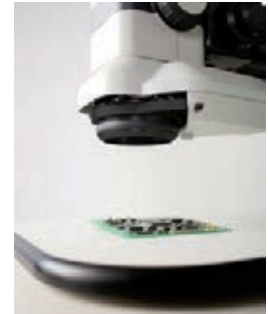

Precision lenses

Lens	Zoom range*	Working distance	Detail with	
			min. zoom** /	max. zoom
0.45x	2.7x - 27x	176 mm	55 mm	5.5 mm
0.62x	3.7x - 37x	128 mm	40 mm	4.0 mm
1.0x	6x - 60x	75 mm	25 mm	2.5 mm
1.5x	9x - 90x	42 mm	16 mm	1.6 mm
2.0x	12x - 120x	29 mm	12 mm	0.8 mm

Multiplier 1.5x

Lens	Zoom range*	Working distance	Detail with	
			min. zoom** /	max. zoom
0.45x	2.7x - 40.5x	176 mm	55 mm	3.7 mm
0.62x	3.7x - 55.5x	128 mm	40 mm	2.7 mm
1.0x	6x - 90x	75 mm	25 mm	1.7 mm
1.5x	9x - 135x	42 mm	16 mm	1.1 mm
2.0x	12x - 180x	29 mm	12 mm	0.8 mm

Multiplier 2.0x

Lens	Zoom range*	Working distance	Detail with	
			min. zoom** /	max. zoom
0.45x	2.7x - 54x	176 mm	55 mm	2.7 mm
0.62x	3.7x - 74x	128 mm	40 mm	2.0 mm
1.0x	6x - 120x	75 mm	25 mm	1.2 mm
1.5x	9x - 180x	42 mm	16 mm	0.8 mm
2.0x	12x - 240x	29 mm	12 mm	0.6 mm

* Maximum permitted zoom range with engaging/disengaging multiplier

** With disengaging multiplier



Lynx EVO complete devices



dpvlink 18856



Article	Type
EVO501	Lynx EVO with ERGO stand and ring light <ul style="list-style-type: none"> with ERGO stand and ring light magnification 10:1 consisting of: EVH001, EVZ040, EVB010, EVL100, EVR050, EVP070
EVO502	Lynx EVO with multi-axis stand and ring light <ul style="list-style-type: none"> with multi-axis stand (without base plate) and ring light magnification 10:1 consisting of: EVH001, EVZ040, EVB020, EVF110, EVL062, EVR050, EVP070
EVO503	Lynx EVO with Ergo stand and rotating optics <ul style="list-style-type: none"> with Ergo stand and rotating optics magnification 10:1 consisting of: EVH-001, EVZ-040, EVB-010, EVR-060, EVP-070
EVO504	Lynx EVO with multi-axis stand and rotating optics <ul style="list-style-type: none"> with multi-axis stand (without base plate) and rotating optics magnification 10:1 consisting of: EVH001, EVZ040, EVB020, EVF110, EVR060, EVP070

Accessories

EVB022	Base plate for multi-axis stand EVB021
VECE022.ESD	ESD mat for base plate EVB022

Lighting



dpvlink 18862



Article	Type
EVP070	Dimmer power unit for EVR050 and EVR060
EVP080	Dimmer power unit for EVS011, EVR050 and EVR060
EVR050	LED ring light with integrated diffuser
EVR060	LED rotating optics
EVS011	LED transmitted light for EVB010

Stereo head / zoom optics



dpvlink 18868



Article	Type
EVH001	Lynx EVO Stereo Dynascope head
EVF110	Focusing module for multi-axis stand
EVL045	Lens x0,45 (magnification x2,7-x27) Delivery with converging lens
EVL062	Lens x0,62 (magnification x3,7-x37) Delivery with converging lens
EVL100	Lens x1,0 (magnification x6,0-x60)
EVL150	Lens x1,5 (magnification x9,0-x90) Delivery with converging lens
EVL200	Lens x2,0 (magnification x12,0-x120) Delivery with converging lens
EVZ040	Lynx EVO magnification 10:1
EVZ045	Multiplier lens x1,5 (Zoom x1,5)
EVZ046	Multiplier lens x2,0 (Zoom x2,0)

Accessories / spare parts



dpvlink 18876



Article	Type
EVB020	Multi-axis stand with base plate EVB022
EVC131	SmartCam, USB HD camera module 5 megapixel
VECE-VF-WIFI.	WIFI-Set for Software ViFox V7 and pixel-fox V7 suitable for EVO Cam and Lynx EVO
VECE-VIFO-V7.	ViFox 7.0 Imaging-Software 7.0 suitable for EVO Cam and Lynx EVO

Accessories

EVB022	Base plate for multi-axis stand EVB021
VECE022.ESD	ESD mat for base plate EVB022
EVB010	Ergo stand with fine/coarse focusing
EVS120	Sliding table 100x100 mm

EVO Cam II



EVO Cam II digital microscope provides ultra-sharp images allowing you to document and verify your samples as well as to analyze faults. The intuitive menu can be set in several languages. Optical magnification up to 300x and full autofocus ensure high-resolution, ultra-sharp images.

Benefit from the advantages:

- efficient dimensioning of complex parts by means of **overlays** or **point-to-point measurements**
- transfer of high-resolution images **to a PC**, directly to an **USB stick** or **wireless** (Wi-Fi adapter required) by touching a button
- **10 programmable** presets can be **exported and imported** ensuring standardized inspections
- simple operation by the **intuitive menu** (also in German)
- **overview function** allows switching between detail view and overall view

Precision lenses:

- high magnification
- high contrast

Lens	Magnification range (24" monitor)	Working distance	Field of view at max. zoom
0.45x	2.3x - 68x	160 mm	7,8 mm x 4.2 mm
0.62x	3.1x - 93.7x	106 mm	5,5 mm x 3.1 mm
1.0x	5x - 151.2x	85 mm	3,5 mm x 2 mm
1.5x	7.6x - 226.8x	43 mm	2,3 mm x 1.2 mm
2.0x	10x - 302.4x	29 mm	1,5 mm x 1.0 mm

Wide-field lenses:

- large working distance
- large magnification range

Lens	Magnification range (24" monitor)	Working distance	Field of view at max. zoom
4 diopters	1.71x - 51.41x	245 mm	10 mm x 5.5 mm
5 diopters	2.12x - 65.5x	197 mm	8 mm x 4.5 mm

Camera:

- magnification 30x optical, 12x digital
- camera resolution 1080p, 1920 x 1080, 1/2.8"CMOS
- frame rate 50fps or 60 fps (switchable)
- output HDMI and USB 3.0
- saved file type .png

360° angular optics

- full 360° rotating view
- quick and easy inspection
- switch between oblique view and direct view
- oblique view at a 34° angle
- with integrated 8-point LED ring light

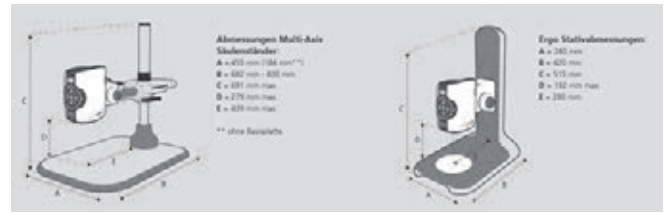

Multi-axis stand EVB021

- precise and robust, ideal for maximal working distance
- height adjustment and counter balance by integrated gas spring
- direct mounting to the work surface or available with additional base plate (EVB022)

Ergo stand EVB010

- compact size, high stability
- transmitted-light illumination (option) for a wider range of sample types
- sliding table (option) facilitates the precise control of sensitive samples, avoids contamination by handling

Double-arm column support S-041EC

- high stability for extended reach
- easy adjustability allowing precise positioning and alignment
- available with platform base or with clamp for direct mounting to the work surface

Column support S-006EC

- stable base plate, ideal for larger specimens
- cost-efficient stand option

Articulated arm stand S-007EC

- ultimate flexibility for extended reach
- multi-point adjustability allows precise positioning and alignment

Table stand S-003EC

- ultra-compact unit with low-profile base
- integrated transmitted-light illumination
- sliding table (option) for an easy control during the inspection of samples



EVO Cam II - complete devices (basic equipment)



Basic equipment consists of EVO-Cam II video microscope, LED incident light, USB stick and stand (**without** lenses, color screen, accessories)

dpvlink 21622



Article	Type
ECO2502	EVO-Cam II video microscope (magnification 30x optical / 12x digital) ECO2502 <ul style="list-style-type: none"> • multi-axis stand without base plate (EVB021) • focus module (EVF111)
ECO2504	EVO-Cam II video microscope (magnification 30x optical / 12x digital) ECO2504 <ul style="list-style-type: none"> • multi-axis stand without base plate (EVB021) • focus module • 360° rotating view (EVR-066)
ECO2501	EVO-Cam II video microscope (magnification 30x optical / 12x digital) ECO2501 <ul style="list-style-type: none"> • with Ergo stand (EVB010) with fine/coarse focus control
ECO2503	EVO-Cam II video microscope (magnification 30x optical / 12x digital) ECO2503 <ul style="list-style-type: none"> • Ergo stand (EVB010) with fine and coarse focus • 360° rotating view (EVR-066)
ECO2513	EVO-Cam II video microscope (magnification 30x optical / 12x digital) ECO2513 <ul style="list-style-type: none"> • double-arm column stand (S-041EC) with focus
ECO2511	EVO-Cam II video microscope (magnification 30x optical / 12x digital) ECO2511 <ul style="list-style-type: none"> • column stand (S-006E) and focus module
ECO2510	EVO-Cam II video microscope (magnification 30x optical / 12x digital) ECO2510 <ul style="list-style-type: none"> • table stand (S-003EC) and focus module
ECO2CE1	EVO-Cam II Video microscope (magnification 30x optical / 12x digital) ECO2CE1 <ul style="list-style-type: none"> • Flexible articulated arm (EVBCE1)
ECO2OEM	EVO-Cam II video microscope (magnification 30x optical / 12x digital) ECO2OEM <ul style="list-style-type: none"> • OEM version

EVO Cam II - Precision and wide-field lenses



- ultra-high resolution
- sharp contrast
- optimal for high magnifications without loss of comfort
- *with 12x digital magnification

Lens	Magnification range (24" monitor)	Working distance	Field of view at max. zoom
0.45x	2.3x - 68x	160 mm	7.8 mm x 4.2 mm
0.62x	3.1x - 93.7x	106 mm	5.5 mm x 3.1 mm
1.0x	5x - 151.2x	85 mm	3.5 mm x 2 mm
1.5x	7.6x - 226.8x	43 mm	2.3 mm x 1.2 mm
2.0x	10x - 302.4x	29 mm	1.5 mm x 1.0 mm
4 diopters	1.71x - 51.41x	245 mm	10 mm x 5.5 mm
5 diopters	2.12x - 65.5x	197 mm	8 mm x 4.5 mm

dpvlink 21656



Article	Type
ECL001	Precision lens 0.45x Working distance 160 mm
ECL002	Precision lens 0.62x Working distance 106 mm
ECL003	Precision lens 1.00x Working distance 85 mm
ECL150	Precision lens 1.5x Working distance 43 mm
ECL200	Precision lens 2.0x Working distance 29 mm
ECL040S	Wide-field objective lens 4 diopters working distance 250 mm
ECL050S	Wide-field objective lens 5 diopters working distance 200 mm
ECL098	Microlens adapter for 5x/10x lenses max. magnification 756x (10x lens)

EVO Cam II - accessories



ECX155 remote control

- improved comfort
- operation of all parameters
- quick access to presets

EVA350 WiFi Dongle

- WLAN adapter
- for a wireless transfer to a computer or a mobile device
- access by multiple users



dpvlink 21623



Article	Type
ECX155	EVO-Cam II remote control
EVA350	WiFi Dongle for EVO Cam II suitable for EVO Cam and EVO Cam II
VECE0138	TFT screen 12 inch Full HD resolution
VECE0134	TFT screen 24" Full HD resolution
EVA316	Light adapter EVA-316 for EVO Cam II for 1.5x and 2.0x lenses
EVA330	UV-LED ring light with PSU
EVS012	LED transmitted light for EVO Cam
EVB024	Base plate with transmitted light unit for ECO2502 suitable for EVO-Cam II ECO2502 (with EVB-021 multi-axis column stand)
EVB022	Base plate for multi-axis stand EVB021
VECE022.ESD	ESD mat for base plate EVB022 suitable for Lynx EVO and EVO Cam
EVB010	Ergo stand with fine/coarse focusing
EVS120	Sliding table 100x100 mm for Ergo stand (EVB010)
VECE-VIFO-V8	Vifox 8.0 Imaging software 8.0 suitable for EVO Cam and Lynx EVO
EVB094	Safety Stop for double-arm column stand S-241 suitable for EVO-Cam II ECO2513 (with double-arm column stand)
EVA331	Polarization filter for incident light
EVA332	Light filter 2800K
EVA333	Light filter 3400K
EVA334	Light filter 4000K
EVA335	Light filter 4350K

VISION VE Cam

Quick. Easy. Compact.

Compact full HD digital microscope system for quick and accurate inspection right where you need it. High quality custom-made optics and digital features combine for superior performance. Ideal for visual inspection or manufacturing quality control.



Designed for productivity, the compact VE Cam 50 & VE Cam 80 offer the power, speed and efficiency of digital imaging in a compact package. Packed with new and established features, VE Cam enables you to do more with maximum space efficiency.

Available with 80mm or 50mm field of view, VE Cam is ideal for many routine inspection tasks. Suitable applications include: electronics, mechanical engineering, plastics, additive manufacturing, and ceramics.

Digital working efficiency: Digital technology supports immediate information capture and share across teams.

Intuitive technology: User friendly interface and common functions make digital systems easy to understand and use.

Wireless viewing: WiFi image mirroring mean colleagues and supervisors can view live images without interrupting workflow.

Improved decision making: Common viewing capability across teams speeds sample and product validation, adding value and reducing cost through increased efficiency.

Features for productivity

Enhanced productivity features include:

- 10 User programmable presets
 - Users can configure and swiftly recall preferred settings for up to 10 settings, for example image settings and functional grids, time stamp and other options. Saves time when changing subjects and aids consistency between users
- 6 hotkeys for instant one touch access to most commonly used presets
- Configurable interface allows most commonly used settings to be shown direct on the screen. Choose to see the features you need



Features for viewing quality

- Precise lighting for precise images: Control of the builtin 8-point ring-light direct from the screen and add transmitted, oblique and flexible illumination through a selection of accessories
- Display two magnifications on screen at one time allowing overview and detail view without changes in settings
- Graphical overlays over the image aid speedy assessment of the subject and can be saved as part of the captured image. Addition of an optional time stamp add traceability



Control as you like

Get the most from the system by controlling it as you need. Intuitive menus can be accessed by mouse, touchscreen, keypad or keyboard with shortcuts configured on a programmable footswitch allowing direct, hands free access to three selectable features.



Multi-language menus: using English, German, Spanish, French, Italian, Portuguese, Chinese, Japanese, Russian

	VE Cam 50	VE Cam 80
Diagonal field of view	50 mm	80 mm
Max. field of view (H x V)	40 mm x 30 mm	64 mm x 48 mm
Min. magnification with 24" monitor	9.97 x	6.23 x
Min. field of view (H x V)	8 x 6	12.8 x 9.6
Max. magnification with 24" monitor	49.9 x	31.5 x
Working distance	163 mm	148 mm

Stand versions



Max. height depending on stand version

Stand version	VE Cam 50	VE Cam 80
Table stand (S240)	75 mm	90 mm
Single arm stand (S206)	119 mm	134 mm
Double arm stand with clamp (S241)	262 mm	277 mm
Double arm stand (S242)	407 mm	422 mm

Shared features

WiFi hotspot - screen mirroring, on-screen quick buttons, save images, pan & zoom of live image, replay saved images, pan and zoom of saved image, area magnifier, pinch zoom (mouse pad/touch screen), 10 presets, time stamp, crosshair & colors, grids & colours, exposure options, white balance options

VE Cam - complete devices (basic equipment)



Basic device comprises VE Cam, mouse, cable and supply unit

[dpvlink 26865](#)



Article	Type
VECM001	VE Cam 50 with single arm stand (S-206) <ul style="list-style-type: none"> • Monitor 24" Full HD LED (VCE0134) • Mounting adapter for stand S-206 (VCM102)
VECM001-80	VE Cam 80 with single arm stand (S-206) <ul style="list-style-type: none"> • Monitor 24" Full HD LED (VCE0134) • Mounting adapter for stand S-206 (VCM102)
VECM002	VE Cam 50 with double arm stand (S-241) <ul style="list-style-type: none"> • Monitor 24" Full HD LED (VCE0134) • Extension cable 1.5 m (VCM104)
VECM002-80	VE Cam 80 with double arm stand (S-241) <ul style="list-style-type: none"> • Monitor 24" Full HD LED (VCE0134) • Extension cable 1.5 m (VCM104)
VECM003	VE Cam 50 with table stand (S-240) <ul style="list-style-type: none"> • Monitor 12" Full HD LED (VCE0138) • Mini monitor bracket (VCM101)
VECM003-80	VE Cam 80 with table stand (S-240) <ul style="list-style-type: none"> • Monitor 12" Full HD LED (VCE0138) • Mini monitor bracket (VCM101)
VECM004	VE Cam 50 with single arm stand (S-206) <ul style="list-style-type: none"> • Monitor 22" Full HD LED touch panel (VCE0135) • VESA monitor bracket (MNT5245) • Mounting adapter for stand S-206 (VCM102)
VECM004-80	VE Cam 80 with single arm stand (S-206) <ul style="list-style-type: none"> • Monitor 22" Full HD LED touch panel (VCE0135) • VESA monitor bracket (MNT5245) • Mounting adapter for stand S-206 (VCM102)
VECM005	VE Cam 50 with table stand (S-240) <ul style="list-style-type: none"> • Monitor 12" Full HD LED (VCE0138) • Mini monitor bracket (VCM101) • Remote control (ECX155)
VECM005-80	VE Cam 80 with table stand (S-240) <ul style="list-style-type: none"> • Monitor 12" Full HD LED (VCE0138) • Mini monitor bracket (VCM101) • Remote control (ECX155)

VISION Makrolite 4K

Ultra 4K Video inspection made easy

Makrolite 4K, a powerful imaging solution ideal for challenging inspection routines. Makrolite 4K provides high definition video images with a wide dynamic range and up to 330x magnification.



Makrolite 4K is easy to use providing both versatility and high performance. Suitable for industrial and life science sectors including production, lab research, research and development, micro assembly, quality control, inbound/outbound product checking, dissection and re-work.

The wide dynamic range of 4K resolution is ideal for reflective subjects, for example solder joints, subjects in shadow, or subjects with low contrast, such as rubber and plastic.

Combined with a wide range of objective lenses and stand options, Makrolite 4K is a flexible solution to your specific inspection needs.

Console control version

The console configuration provides direct HDMI connection to the monitor for live display with full control of zoom and all camera settings.

Camera controls include:

- Zoom. 20:1 zoom ratio, with magnification range 3x to 330x
- Autofocus and manual focus
- Aperture, exposure (AE, AP and ME modes)
- Gain, white balance, image flipping



PC control

Connecting Makrolite 4K to a PC with our dimensioning software, ViPlus, extends its capabilities to include image capture, annotation, on-screen measurement, data/image report generation and a range of image processing tools.



ViPlus software offers:

- Control of camera settings
- Image capture in JPEG, PNG, BMP and TIFF formats
- Annotation tools, including markers and measures
- Measurement tools such as distance, angle, diameter, area
- Import of CAD files for inspection
- Image processing such as colour inversion, shape detection, focus stacking, overlays
- Generation of reports in Excel and other formats

Data sharing

Share 4K images, videos or reports with colleagues, suppliers, customers and regulators easily and instantly across networks. The option to save images and video to a USB drive is also available with both the PC and the console configurations.

Flexible solution

Whatever your application requirements, Makrolite 4K is available with a stand that perfectly meets your needs.



Ergo stand (EVB010)

- Small footprint and exceptional stability for high magnification applications
- Available with floating stage option for smooth and precise control of components



Table stand (S-240)

- Compact, high stability and small footprint
- Integrated intensity adjustment for incident and transmitted lighting



Single arm stand (S-206)

- Ideal for larger components
- Stable platform with base or attached directly to the work surface
- Good freedom of movement



Double arm stand (S-241)

- For applications requiring greater reach without compromising stability
- Easy adjustment for precise positioning and alignment
- With either base or clamp for direct mounting on the working surface



Multi-axis stand (EVB021)

- Precise and robust
- Ideal for industrial applications requiring maximum work space
- Integrated gas strut adjustment is quick and effortless
- Extended reach (maximum throat 439 mm)

Lenses	Working distance	Field of view at		
		min. magnification	max. magnification	
			(Optical zoom)	(Digital zoom)
0,45x	170 mm	212 mm (3x)	8.8 mm (45x)	4.4 mm (90x)
0.62x	112 mm	201 mm (3x)	10.2 mm (57x)	5.1 mm (114x)
1.0x	84 mm	61 mm (10x)	6.2 mm (100x)	3.1 mm (200x)
1.5x	43 mm	28 mm (20x)	4.2 mm (150x)	2.1 mm (300x)
2.0x	29 mm	24 mm (20x)	3.2 mm (165x)	1.6 mm (330x)

Camera		PC requirements	
Sensor type	CMOS 1/2,5" 8,51 MP	Operating system	Windows 10
Camera output	4K, 2160p/30fps	Processor	i7 or later version, 3GHz
Focus	Autofocus or manual focus	Graphics	min. HDMI 2.0
Image	Ultra HD 2160p (3840 x 2160)	Memory	min. 8GB RAM
		Scalability	x4 oder x8 PCI express card

Makrolite 4K - complete devices (basic equipment)



Basic device comprises Makrolite 4K camera, LED ring light and control console

dpvlink 26858



Article	Type
M4K2501	Makrolite 4K with ergo stand (EVB010) <ul style="list-style-type: none"> • Objective x 1.00 (ECL003) • External recording module (M4K105) • TFT screen 27" 4K (VECE4KM) • M4K adapter for ergo stand / multi-axis stand (S-416)
M4K2502	Makrolite 4K with multi-axis stand (EVB021) <ul style="list-style-type: none"> • Focusing module (EVF111) • Objective x 0.62 (ECL002) • External recording module (M4K105) • TFT screen 27" 4K (VECE4KM) • M4K adapter for ergo stand / multi-axis stand (S-416)
M4K2503	Makrolite 4K with ergo stand (EVB010) <ul style="list-style-type: none"> • Objective x 1.00 (ECL003) • TFT screen 27" 4K (VECE4KM) • Minitower PC INTEL i7 Win10pro SSD (VECE0142) • Frame Grabber card 4K (M4K106) • ViPlus software (VIS001) • M4K adapter for ergo stand / multi-axis stand (S-416)
M4K2504	Makrolite 4K with multi-axis stand (EVB021) <ul style="list-style-type: none"> • Focusing module (EVF111) • Objective x 0.62 (ECL002) • TFT screen 27" 4K (VECE4KM) • Minitower PC INTEL i7 Win10pro SSD (VECE0142) • Frame Grabber card 4K (M4K106) • ViPlus software (VIS001) • M4K adapter for ergo stand / multi-axis stand (S-416)
M4K2513	Makrolite 4K with double arm stand (S-241) <ul style="list-style-type: none"> • Objective x 1.00 (ECL003) • TFT screen 27" 4K (VECE4KM) • Minitower PC INTEL i7 Win10pro SSD (VECE0142) • Frame Grabber card 4K (M4K106) • ViPlus software (VIS001)
M4K2511	Makrolite 4K with single arm stand (S-206) <ul style="list-style-type: none"> • Objective x 0.62 (ECL002)

TEK-Scope HD inspection system

TEK-SCOPE PLUS HD optical inspection system



TEK-SCOPE PLUS produces high-quality, distortion-free FHD images of up to 1080p with no delay and with excellent depth of field. LED lights provide a shadow-free illumination. TEK-SCOPE PLUS has to be connected to a monitor.



- Monitor connection via DisplayPort / HDMI output
- Live-streaming images on monitor (HD 1280x720 / FHD 1920x1080)
- optical magnification up to 46x
- digital magnification up to 460x (recommended maximal magnification for trouble-free images up to 300x)
- Full HD images up to 1080px
- image storage directly on USB stick possible
- 310 mm working distance enables enough space for mounting, repair and rework



Advantages:

- user-friendly system
- promotes correct body posture
- large depth of field
- Auto focus for a quicker inspection of objects at different heights and magnifications



Optional accessories:



Inspection from any angle, including 4D lens



X-Y precision gliding stage

dpvlink 23165

Article Type

I-TEK.SCOPE-PLUS **TEK-SCOPE PLUS HD optical inspection system**



Accessories TEK-SCOPE PLUS



dpvlink 22037

Article Type

I-TEK.TILT-PLUS **TEK-SCOPE 360° inspection table and 4D lens**
ESD version

I-TEK.XY **TEK-SCOPE PLUS XY inspection table**



Cam BETA

Cam BETA - Digital inspection magnifier



CamB - Digital inspection magnifier for the easy, portable inspection of inaccessible spaces.



CamB provides an ideal illumination of your macro shots. Select between 4 lighting positions. No digital camera or smartphone is required for documenting faults and inspecting immobile subjects.

- 4 LEDs with 4 lighting positions
- preconfigured lighting for close-ups
- safe connection via HDMI (no WiFi connection)
- with support leg for ideal distance
- for left- and righthanders



Technical data:

Display	4.3 inch (10.9 cm)
Display mode	color display, black and white, black, inverted black and white, grey scale
Magnification	4 x, 8 x, 16 x and 20 x
Illumination	4 x LED, optimized for magnified imaging 4 settings: 100 %, 75 %, 50 %, 25 %
Dimension grids	1 mm ² grid simple X / Y on-screen dimensioning virtual caliper
Measurements	Yes (inch / mm)
Image capture resolution	1280 x 720, JPEG
Video output	Mini-HDMI-TV output
Connections	Micro-USB connection for image download and charging Mini-HDMI for monitor TV output
Rechargeable battery	Lithium ion, 6 hour continuous operation
Dimensions	283 mm (L) x 88 mm (H) x 22 mm (W)
Weight	205 g
Image storage	20.000
Internal memory	4 GB
Scope of delivery	CamB, soft case, USB cable, Mini-HDMI cable, TV output cable, lanyard, cleaning cloth, user guide

dpvlink 21668

Article Type

CMB001 **Cam BETA - Digital inspection magnifier**



Magnifiers

Watchmaker's magnifier

ESCHENBACH



The watchmaker's magnifiers by Eschenbach are comfortable to wear. The anthracite plastic case prevents scattered light on the lenses providing a clear contrast.

- biconvex (curved outwards on both sides) or plano-convex (curved outwards on one side)
- plastic of low flammability

dpvlink 20430

Article	Magnification	Diameter in mm	Lens
Watchmaker's magnifier			
ES-1124110	10x	25	aspheric
ES-11243	3x	25	plano-convex
ES-11245	5x	25	plano-convex
ES-11247	7x	25	plano-convex



Designo folding magnifier

ESCHENBACH



- slide-out magnifier for an optimum protection of the lens
- very handy and small
- quick and comfortable magnification

dpvlink 20844

Article	Magnification	Diameter in mm	Diopters
ES-1711	5x	30	20



Precision folding magnifier brass

ESCHENBACH



Folding magnifier of matt chrome-plated housing with eyelet. Lens frame of black painted metal

dpvlink 20774

Article	Magnification	Diameter in mm	Lens
Precision folding magnifier brass			
ES-11766	6x	21	aplanatic
ES-11768	8x	21	aplanatic
ES-117612	12x	15	aplanatic
ES-117610	10x	21	aplanatic
ES-1187	4x/6x	27	biconvexe
ES-118410	10x	15	achromatic
ES-118420	20x	17	achromatic



Precision folding magnifier plastic

ESCHENBACH



High-quality silicate lens with polyamide housing. The housing is non-breakable and dust-tight when closed.

dpvlink 20780

Article	Magnification	Diameter in mm	Lens
Precision folding magnifier plastic			
ES-11869	3x/6x	23	achromatic
ES-118210	10x	23	aplanatic



Mobilent folding magnifier

ESCHENBACH



- high-magnification folding magnifier
- aspheric PXM[®] lightweight lens
- distortion-free image with edge-to-edge sharpness
- plastic case encloses the lens and is dust-tight
- always ready-to-hand with neck cord

dpvlink 20840

Article	Magnification	Diameter in mm	Diopters
Mobilent folding magnifier			
ES-171094	4x	35	16
ES-171097	7x	35	28
ES-1710910	10x	35	38



Mobilent LED folding magnifier



- high-magnification folding magnifier
- with efficient LED illumination
- aspheric PXM® lightweight lens
- distortion-free image with edge-to-edge sharpness
- plastic case encloses the lens and is dust-tight
- included lanyard
- inclusive 1 x CR 2032 battery

dpvlink 22703



Article	Magnification	Diameter in mm	Diopters
Mobilent LED folding magnifier			
ES-152094	4x	35	16
ES-152097	7x	35	28
ES-1520910	10x	35	38

Stand magnifier aspheric



- stand magnifier with very scratch-resistant lens
- can be used as a high magnification vision aid
- open base for working under the lens (with ES-2626 and ES-2628)
- transparent base allows excellent illumination from all sides

dpvlink 20851



Article	Magnification	Diameter in mm	Lens
ES-2626	6x	50	aspheric
ES-2628	10x	35	aspheric
ES-1153	8x	25	aplanatic

easyPocket illuminated pocket magnifier



- pocket magnifier with optional illumination
- magnification in a credit card format
- ultra-flat and lightweight
- including case for storage
- with 2 x 2025 button battery

dpvlink 20798



Article	Magnification	Diameter / dimension [mm]	Lens
ES-152110	3x	86 x 54	aspheric
ES-152111	3x	86 x 54	aspheric
ES-152122	4x	86 x 54	aspheric

easyPocket XL illuminated pocket magnifier



- especially large visual field with super-flat lens
- including case for safe storage
- LED has an almost unlimited service life
- can be used as stand magnifier with the integrated strap
- including 2 x 2032 button battery

dpvlink 20802



Article	Magnification	Diameter / dimension [mm]	Lens
ES-152210	2.5x	78 x 50	aspheric
ES-152211	2.5x	78 x 50	aspheric

mobilux LED illuminated pocket magnifier



mobilux® LED magnifier is easy to use. Always ready-to-hand with a large, easy to operate light switch and eyelet for lanyard.

- 3 attachable transparent filters focusing light and improving the light intensity by up to 40%
- battery service life up to 10x longer
- incl. 2 x AA batteries
- including case to attach on the lens



dpvlink 20788



Article	Magnification	Diameter / dimension [mm]	Lens
ES-151110	10x	35	aspheric
ES-151112	12.5x	35	aspheric
ES-15112	3x	60	aspheric
ES-15122	3x	90 x 54	aspheric
ES-15113	3.5x	75 x 50	aspheric
ES-15114	4x	75 x 50	aspheric
ES-151141	4x	60	aspheric
ES-15115	5x	58	aspheric
ES-15116	6x	58	aspheric
ES-15117	7x	35	aspheric

powerlux illuminated magnifier



- illuminated stand magnifier
- even, shadow-free illumination
- very scratch-resistant
- ergonomic design
- economical power consumption due to automatic shut-off function after 30 minutes
- suitable for right and left handers
- including 3 x AA batteries

dpvlink 20808



Article	Magnification	Diameter in mm	Diopters	Light color
powerlux illuminated magnifier				
ES-158614	3.5x	58	14	8.000 K
ES-1586141	3.5x	58	14	3.000 K
ES-158620	5x	58	20	8.000 K
ES-1586201	5x	58	20	3.000 K
ES-158628	7x	58	28	8.000 K
ES-1586281	7x	58	28	3.000 K

Micro illuminated magnifier LED



- micro-magnifier with LED illumination
- for inspecting a wide variety of surfaces such as metals, textiles, varnishes etc.
- detailed examination of depressed or raised features
- high level of brightness due to large lens aperture
- precise focus setting with swivel
- illumination switchable if required
- glass lens of high-quality silicate

dpvlink 20870

Article	Type
ES-11744	Micro illuminated magnifier LED



laboMED attachment magnifier



- free hands for working
- high level of magnification
- lens clamp made of glass-fiber reinforced plastic
- discreet metal frame with matt black finish
- with storage box
- not suitable for persons wearing spectacles

dpvlink 20821

Article	Magnification	Diopters	Lens	Working distance
ES-164450	1.7x	2,5	plano-convex	400
ES-164451	2x	2,5	plano-convex	250
ES-164452	2.5x	5	plano-convex	180
ES-164453	3x	7,75	plano-convex	130



laboClip attachment magnifier



- Attachment magnifier can be easily attached to the wearer's spectacle frame
- comfortable working distance
- low weight
- clamping element made of glass-fiber reinforced plastic
- with storage box

dpvlink 20822

Article	Magnification	Diopters	Lens	Working distance
ES-164617	1.7x	2,5	binocular	400
ES-164620	2x	2,5	binocular	250
ES-164625	2.5x	5	binocular	180
ES-164630	3x	7,75	binocular	130
ES-164640	4x	16	monocular	55
ES-164670	7x	28	monocular	32



laboComfort headband magnifier



- headband magnifier with 1.7-fold to 3-fold magnification
- height of the magnifier shield can be adjusted individually via adjustable headband strap
- when not used the shield can be simply lifted up
- suitable for persons wearing spectacles
- dark grey, closed plastic shield against diffused light with integrated lens bracket
- laboComfort can only be used with binocular lenses

dpvlink 20835

Article	Magnification	Diopters	Lens	Working distance
ES-164817	1.7x	2,5	plano-convex	400
ES-164820	2x	2,5	plano-convex	250
ES-164825	2.5x	5	plano-convex	180
ES-164830	3x	7,75	plano-convex	130



Aspheric reading magnifier



- for reading and looking at pictures
- concealed eyelet in the end of the handle for neck cord
- including lanyard
- genuine leather case separately available under dpvlink 20876

dpvlink 20854

Article	Magnification	Diameter / dimension [mm]	Lens
ES-265550	6x	50	aspheric
ES-265560	5x	58	aspheric
ES-265570	4x	70	aspheric
ES-2655750	3.5x	75 x 50	aspheric



Precision scale magnifier



- distortion-free and pin sharp image
- fine focusing via easy-grip focusing ring
- with measuring scale, measuring range 20 mm, 1/10 mm
- housing made of glass-fiber reinforced polyamide
- including plastic box with space for other scales

dpvlink 20861

Article	Magnification	Diameter in mm	Lens
ES-115410	10x	23	achromatic
ES-11547	7x	23	achromatic



Scale magnifier



- magnifier with measuring scale
- 10-fold magnification
- 38 diopters
- LED scale magnifier ES-155074 requires 2x C battery 1.5 V
- with case

dpvlink 20805

Article	Type
ES-155071	Scale magnifier
ES-155074	LED scale magnifier



Scribolux stand magnifier



- illuminated stand magnifier
- lots of space for writing and reading
- magnifier base with open design
- bright, even and glare-free illumination
- shadow-free working with both hands under the scratch-resistant lens
- low power consumption due to automatic shut-off function after 30 minutes
- including 3 x AA batteries

dpvlink 20864

Article	Magnification	Diopters	Lens
ES-156512	2.8x	7	aspheric



Maintenance cleaning

EPAclean® Cleaning supplies



Quick and simple cleaning for conductive surfaces in ESD areas. Clean reliably your work place and table coverings as well as floorings and other surfaces. The high-quality of the new EPAclean® cleaning series professional is ready-to-use and available as spray bottle and refill canister. When used for maintenance cleaning the EPAclean® concentrate ESD Floor Cleaner professional is very economical. If a basic cleaning is necessary, the ESD Basic cleaner professional concentrate produces excellent results.

ESD Cleaner professional



EPAclean® ESD Cleaner professional for the quick and easy cleaning of ESD surfaces



- ready-to-use cleaner
- binds loose dust and fine dirt in a hygienic way
- cleans without streaking and does not build up layers
- spray nozzle allows damp-wiping due to a controlled and well-measured dispersion of the cleaner
- prevents overdosage and swelling effects caused by excessive moisture
- surface dries completely and is usable within a very short period of time

[dpvlink 22449](#)

Article	Type
2920.2001	EPAclean® ESD Cleaner Professional 1l aerosol
2920.2005	EPAclean® ESD Cleaner Professional 5 liter canister



ESD Floor Cleaner professional



EPAclean® ESD Floor Cleaner professional suitable for the maintenance cleaning of all ESD PVC floorings



EPAclean

- excellent dirt-binding characteristics, even with greasy residues
- no leaching of the surface
- no formation of grey haze
- cleaning without stripes
- concentrate
- dilution ratio 1:200

[dpvlink 22452](#)

Article	Type
2920.2010.K	EPAclean® ESD Floor Cleaner Professional 10 liter canister



ESD Basic Cleaner professional



EPAclean® ESD Basic Cleaner professional for the gentle and effective basic cleaning of ESD floors



EPAclean

- for the removal of waxes, wash products, care coatings as well as adhesive residues and building dirt during the final cleaning after construction work with a given PU treatment at the factory
- high dissolving power and of gentle low alkalinity
- all-purpose basic cleaner for all elastic floorings
- concentrate
- dilution ratio 1:10

[dpvlink 22454](#)

Article	Type
2920.2050.K	EPAclean® ESD Basic cleaner Professional 5l canister



Microfiber cloths

Floor mop Supra-Klapp / -Klett



Aluminum telescopic handle:

With stable internal locking, variable size setting from 80 cm - 160 cm, handle: Ø 23.5 mm

Floorcloth holder Supra-Klapp:

A high-quality, robust folding system floor cloth holder with a width of 40 cm.

Floorcloth holder Supra-Klett:

Easy handling, by trapezoidal shape ideal for corners. velcro strips at the bottom hold the special celcro microfiber floorcloths.

dpvlink 8482

Article	Type
2900.MFT.590	Aluminum telescopic handle
2900.MFT.500	Mop holder Supra-Klapp for microfiber cloth Supra, with pockets (telescopic handle separately available)
2900.MFT.510	Mop holder Supra-Klett for microfiber cloth Supra-Klett (telescopic handle separately available)



Microfiber cloth Supra



Machine washable, recommended up to 60°C (max. 95°C), do not use a fabric softener.

Supra 100 - moist mop for a quick cleaning suitable for all smooth floor surfaces (PVC, parquet, laminate, etc.). Ideal for the spray method. Quickly ready to walk on.

Supra 105 - dry mop, wet mop, moist mop, dust mop for smooth and grooved floors and rough surfaces.

Supra 110 - extra fine mop with long, fleecy pile. 30% more water absorption and high dirt-holding capacity. For PVC, parquet, laminate and other smooth floors.

dpvlink 8471

Article	Type
2900.MFT.100	Microfiber cloth Supra 100 (white/blue dots) Size 46 x 17 cm, with pockets, extra thick, short piled, material: 100% microfiber
2900.MFT.105	Microfiber cloth Supra 105 (white/blue stripes) Size: 46 x 17 cm, with pockets, high-pile, material: 82% microfiber, 18% cotton
2900.MFT.110	Microfiber cloth Supra 110 (green, white) Size: 46 x 17 cm, with pockets, high-pile / long fleecy floor, material: 100% microfiber



Microfiber cloth Supra Klett



Machine washable, recommended up to 60°C (max. 95°C), do not use a fabric softener.

Supra 200 - wet mop for a quick cleaning suitable for all smooth surfaces (PVC, parquet, laminate, etc.). Ideal for the spray method. Quickly ready to walk on.

dpvlink 8475

Article	Type
2900.MFT.200	Microfiber cloth Supra 200-Klett (white/blue dots) Size 47.5 x 14.5 cm, velcro fastener, short piled, extra thick, material: 100% microfiber



Microfiber cloths



The microfiber is an extremely thin fiber which is splitted again into many little fibers in a special process. This creates hollow spaces that store the water very well and release it during the cleaning again.

Important! Wash before the first use!

Washable up to 90°C. Do not use fabric softeners as the fibers may stick. High dirt-holding capacity.

Primo microfiber cloth

- Wet the cloth before using and wring it out well.
- Suitable for all surfaces (chrome, monitor, sanitary, stainless steel, etc.)
- Streak-free without cleaning additives

Crystal microfiber cloth

- especially suitable for glass surfaces

dpvlink 4643

Article	Type
2900.MFT-K.plus	Crystal window microfiber cloth 50 x 70 cm, VPE = 5
2900.MFT-P.blau	Primo-Aktiv microfiber cloths 40 x 40 cm, light blue, PU = 10
2900.MFT-P.rot	Primo-Aktiv microfiber cloths 40 x 40 cm, red, PU = 10
2900.MFT-P.gelb	Primo-Aktiv microfiber cloths 40 x 40 cm, yellow, PU = 10
2900.MFT-P.grün	Primo-Aktiv microfiber cloths 40 x 40 cm, green, PU = 10



Wipes ESD



Dissipative ESD wipes for the cleaning or drying of stencils, printed circuit boards, optical components or machine parts.

- 100% synthetic, knitted polyester
- no metal or carbon fibers
- for the use with conventional cleaners

In compliance with ESD standard DIN EN 61340-5-1

dpvlink 5828

Article	Type	L [mm]	W [mm]	PU
6200.20	Wipe (pink)	230	230	50 piece



ESD cleaning cloths



Dissipative cleaning cloths of carbon fiber
Suitable for the use in ESD zones

dpvlink 15767

Article	Type	L [mm]	W [mm]	PU
6201.1003	ESD cleaning cloths	230	230	150 piece



Wipes

Dissipative ESD wipes for cleaning or drying stencils, printed circuit boards, optical components or machine parts



- material: 67% knitted polyester, 29% micro denier nylon, 4% carbonized yarn
- dimensions: 230 x 230 mm
- color: white
- not washable

In compliance with ESD standard
DIN EN 61340-5-1

dpvlink 17717

Article	Type	L [mm]	W [mm]	PU piece
8850.WP	Wipes	230	230	50 piece



Cleaning supplies

ESD Cleaner



- special cleaners for dissipative and conductive surfaces
- no negative influence on the resistance values
- easy cleaning of smudges and beverage stains, pencil and felt pen strokes as well as inks
- easy application by spray



dpvlink 4632

Article	Packaging type	Volume
2900.570	spray bottle	1.0 l
2900.571	canister	5 l



ESD Floor Cleaner R1000



- cleaning agent for ESD floors
- no negative influence on the resistance values
- easy cleaning of normal contamination
- for basic cleaning and maintenance cleaning
- Dilution ratio 1:200 (50 ml per 10 liter bucket)



dpvlink 4638

Article	Packaging type	Volume
2900.560.2.5	canister	2.5 l
2900.560.5	canister	5 l
2900.560.10	canister	10 l



ESD Floor Polish



- dissipative, liquid floor wax
- suitable for insulating floor materials such as PVC, linoleum and parquet
- silky, shiny surface
- cost-effective solution
- quick and easy application with conventional cleaning equipment
- regular treatment necessary



Consumption: approx. 1 liter / 30 - 40 m² (depending on floor conditions)

In compliance with ESD standard DIN EN 61340-5-1

dpvlink 4636

Article	Packaging type	Volume
2900.581	canister	5 l



ESD Floor Stripper



- removes ESD Floor Polish safely and effectively
- for cleaning of the floor before sealing
- no negative effects on electrical resistance values
- listed by the Federal Environment Agency with UBA No.: 0233-0255



Consumption: approx. 1 l / 10 m² (depending on the floor conditions)

dpvlink 10134

Article	Packaging type	Volume
2900.580	canister	5 l



Component cleaning

Sticks

Foambuds cleaning sticks



Special, long plastic sticks with foam tip for cleaning read/write heads and tape drives

- The flexible sticks (15 cm) allow a thorough cleaning even of inaccessible spaces
- The foam tip does not wear out and offers a perfect cleaning
- The cotton core serves as fluid reservoir

dpvlink 2440

Article	Type
FBU100	Cleaning swabs Sticks with foam tip, box with 100 buds



PC Buds plastic sticks



Plastic sticks with wide, flexible foam tip

- Sticks (13 cm) with 13 mm wide foam tip
- The abrasion-resistant foam tip ensures a careful surface cleaning
- The flexible, narrow head allows a thorough cleaning of even inaccessible spaces
- Reclosable bag

dpvlink 2507

Article	Type
PCB025	PC Buds plastic sticks Sticks with foam tip for keyboards, bag with 25 buds



Safebuds wooden sticks



Wooden sticks with a tip made of pure cotton.

- To reach even difficult corners and inaccessible places such as the computer hardware
- An insoluble adhesive fixes the cotton tip on the stick
- Reclosable bag

dpvlink 2521

Article	Type
SBU000	Safebuds wooden sticks Lint-free cotton swabs, box with 1.000 buds



Cleaning sticks / Swabs - polyurethane (PU)



- Head: polyurethane (PU) foam
- stick: polypropylene
- cleanroom class 100 / ISO 5

dpvlink 22898

Article	Type
1000.325	Cleaning sticks PU Head: 4.8 x 15 mm Stick: 3 x 137.3 mm PU = 500 pieces



ESD cleaning sticks / Swabs – polyurethane (PU)



- Head: polyurethane (PU) foam
- stick: polypropylene
- cleanroom class 100 / ISO 5

In compliance with the ESD standard
DIN EN 61340-5-1 

dpvlink 22889



Article	Type
1000.301	ESD cleaning sticks PU Head: 4.7 x 20.6 mm Stick: 2.5 x 131.8 mm PU = 50 pieces
1000.300	ESD cleaning sticks PU Head: 4.0 x 14.2 mm Stick: 2.3 x 62 mm PU = 50 pieces

Cleaning sticks / Swabs - polyester



Swabs ideal for the use with cleaners, degreasers, flux remover and other solvents for a quick and precise cleaning

- head: knitted polyester / nonwoven polyester
- stick: polypropylene
- acid and solvent resistant
- high resistance due to sealed edges
- ideal for cleaning raised outlines
- no particle residues due to fiber-free structure

dpvlink 22869



Article	Type
I-IT36850	Swabs Polyester Head: 4.7 x 18.9 mm Stick: 3.1 x 147 mm PU = 100 pieces
I-IT38040	Swabs Polyester Head: 2.4 x 11.2 mm Stick: 2.3 x 69 mm PU = 100 pieces
I-IT38140	Swabs Polyester Head: 1.6 x 12.1 mm Stick: 2.3 x 69 mm PU = 100 pieces
I-IT38540	Swabs Polyester Head: 1.0 x 11.7 mm Stick: 2.3 x 69 mm PU = 100 pieces

Cleaning sticks / Swabs - wrapped foam



Swabs - cleaning sticks ideal for the use with cleaners, degreasers, flux removers and other solvents for a quick and precise cleaning

- head: wrapped foam (PU)
- stick: nylon
- excellent particle confinement
- suitable as solvent applicators
- highest wearing resistance, therefore ideal for removing persistent contaminations
- especially fine tip for the use in tight areas

dpvlink 22874



Article	Type
I-IT21050	Cleanroom sticks wrapped foam Head: 3.7 x 27.5 mm Stick: 2.5 x 71 mm PU = 100 pieces

Cleaning sticks / Swabs – polyurethane (PU)



Swabs - cleaning sticks ideal for the use with cleaners, degreasers, flux removers and other solvents for a quick and precise cleaning

- head: polyurethane (PU) foam
- stick: polypropylene
- fine (100 ppi), reticular foam for excellent particle confinement
- open-cell structure assures good solvent binding
- no particle residues due to fiberless structure
- contains no adhesive or binder - therefore no contaminations

dpvlink 22793



Article	Type
I-IT41050	Cleaning sticks PU Head: 3.3 x 10.2 mm Stick: 2.6 x 72 mm PU = 100 pieces
I-IT44070	Cleaning sticks PU Head: 2.7 x 9.9 mm Stick: 2.4 x 80 mm PU = 100 pieces
I-IT48040	Cleaning sticks PU Head: 2.5 x 10.5 mm Stick: 2.2 x 68 mm PU = 100 pieces

ESD cleaning sticks Sticky Swabs

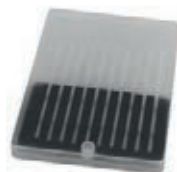

Sticky Swabs - ESD cleaning sticks for the use in cleanroom environments (ISO 4, ISO 5)
For removing particles from tight, difficult to reach areas

- ESD safe
- soft, absorbing, non-abrasive tip
- lint-free
- leaves no adhesive residues
- cleanroom class 100 / ISO 5

In compliance with the ESD standard DIN EN 61340-5-1 

dpvlink 22768



Article	Type
I-IT01401/10	ESD cleaning sticks Sticky Swabs Head ø: 1 mm, stick: 2.0 x 70 mm 10 pieces/box
I-IT01401/25	ESD cleaning sticks Sticky Swabs Head ø: 1 mm, stick: 2.0 x 70 mm 25 pieces/box
I-IT01402/10	ESD cleaning sticks Sticky Swabs Head ø: 2 mm, stick: 2.0 x 70 mm 10 pieces/box
I-IT01402/25	ESD cleaning sticks Sticky Swabs Head ø: 2 mm, stick: 2.0 x 70 mm 25 pieces/box
I-IT01403/10	ESD cleaning sticks Sticky Swabs Head ø: 3 mm, stick: 2.0 x 70 mm 10 pieces/box
I-IT01403/25	ESD cleaning sticks Sticky Swabs Head ø: 3 mm, stick: 2.0 x 70 mm 25 pieces/box
I-IT0140123/75	ESD cleaning sticks Sticky Swabs set 25 x ø head 1 mm, 25 x ø head 2 mm, 25 x ø head 3 mm Mixed box with 75 pieces

Wipes

Safecloths dry cloths



- Pressed nonwoven cloths for general cleaning
- Especially useful for housings, furniture and whiteboards
 - Packed in a practical, reclosable bag
 - Applicable with Foamclene, Maxiclene and Whiteboardclene
 - Absolutely lint-free, especially absorbent

dpvlink 2523

Article	Type
SCH050	Safecloths dry cloths Nonwoven cloths 320 x 340 mm, bag with 50 cloths.

Safewips cotton cloths



- Cloths made of pure cotton
- 100% pure cotton without additives or brightening agents
 - cut contrary to the seam
 - To use with AF Spray, Isoclene, Headclene, Safeclene 2000, Safecleans

dpvlink 2525

Article	Type
SW1100	Safewips cotton cloths Lint-free, 230 x 230 mm Bag with 100 cloths
SW1400	Safewips cotton cloths Lint-free, 100 x 100 mm Box with 4 bags each with 100 cloths

Safetiss paper wipes



- High-quality single-ply paper wipes
- Highly absorbent, lint-free
 - Excellent tear strength (wet and dry)
 - Applicable with Screenclene, Foamclene, Maxiclene

dpvlink 2528

Article	Type
ST1200	Safetiss paper wipes 220 x 230 mm, dispenser box with 200 wipes

Safepads cleaning cloths



- Lint-free cloths, impregnated with cleaning fluid
- Contains 99.7% pure isopropyl alcohol
 - Recommended for the professional technical application
 - Ideal to clean inaccessible places

dpvlink 2425

Article	Type
SPA100	Safepads cleaner for surfaces Box with 100 wipes, individually packed

Aerowipes

ELECTROLUBE



- The Aerowipes are impregnated with a non-hazardous, water-based liquid
- The liquid evaporates quickly and leaves a residue-free surface
- Aerowipes cause no corrosion and are low in odor

dpvlink 10823

Article	Type
ARW300	Aerowipes - ARW 300 300 wipes / bucket

Cleaning set



Compact cleaning set for the care of all surfaces of PCs and workstations.

- Powerful foam cleaner for cases and keyboards
- Antistatic wet/dry wipes for screen filters and monitors
- Cleaning wipes and cotton swabs for the use with foam cleaner

dpvlink 2532

Article	Type
SCK000	Cleaning set 1 foam cleaner (87 ml), 10 pairs of cleaning wipes for screens, 20 nonwoven cloths, 25 cotton sticks

Hygiene / Disinfection

SaniSchutz Hand sanitizer

Hand sanitizer against envelope viruses.



- for a hygienic hand disinfection on washed, dry hands
- excellent immediate effect
- excellent tolerance even with long-term application
- higher skin moisture in case of multiple use
- consumption approx. 3 ml per application

dpvlink 23917

Article	Type
2900.605.100	SaniSchutz Hand sanitizer 100 ml bottle
2900.605.5	SaniSchutz Hand sanitizer 5 liter canister

SaniSchutz Surface disinfectant

Ready-made surface disinfectant with virucidal, bactericidal and fungicidal effect.



- ready-made solution for wipe disinfection
- suitable for dissipative surfaces
- suitable for non-porous, hard, washable (water-resistant) surfaces and things
- good cleaning effect at a comparatively low pH value
- available as spray bottle (500 ml) or canister (10 liters)
- consumption approx. 500 ml for 10 m²

dpvlink 23920

Article	Type
2900.610.500	SaniSchutz Surface disinfectant 500 ml spray bottle
2900.610.10	SaniSchutz Surface disinfectant 10 liter canister



Disinfectant Cleaner C, concentrate

Surface disinfectant cleaner concentrated with virucidal, bactericidal and fungicidal effect.



- for wipe application
- alcohol-free liquid concentrate
- good cleaning effect at a comparatively low pH value
- disinfection of non-porous, hard, washable (water-resistant) surfaces and things
- concentrate dilution ratio 1:20 (500 ml with 10 liters of water each)
- consumption approx. 1 liter for 100 m²

dpvlink 23915

Article	Type
2900.595.5	Disinfectant Cleaner C concentrate 5 liter canister



Empty bottle 1 liter with spray head



- empty bottle for refilling
- with spray head for a fine spray
- with screw cap
- capacity 1 liter
- material: plastic

dpvlink 23960

Article	Type
2900.LF	Empty bottle 1 liter with screw cap and spray head



Antistatic cleaning / coating

Techspray ESD coating spray



ESD Coating spray

- permanently dissipative coating
- adhesion on many surfaces
 - glass
 - metal
 - plastic
- surface resistance 10⁶ to 10⁹ Ohm
- can be used at an air humidity of 0 to 100%
- robust and non-flaking
- without silicone
- usable up to 155°C

dpvlink 23499

Article	Type
TS1756-8S	Techspray ESD coating spray Licron



AFC Antistatic foam cleaner



AFC of antistatic foam cleaner

- Safe on all plastics
- Protects against electrostatic charge
- Biodegradable
- Nonflammable

dpvlink 2608

Article	Type
AFC200D	AFC Antistatic foam cleaner, 200 ml aerosol can
AFC400D	AFC Antistatic foam cleaner, 400 ml aerosol can



CTC Antistatic foam cleaner



CTC antistatic foam cleaner

- Long-lasting antistatic protection on glass, plastic and other synthetic materials
- Removes stubborn dirt and soot
- Relatively high pH reduces contact time on metals
- Shake well before using

dpvlink 7572

Article	Type
CTC400H	CTC Antistatic foam cleaner, 400 ml aerosol can



ASA Antistatic spray



ASA antistatic spray

- Protects against electrostatic charge
- Non-foaming
- Long-lasting effect
- Nonflammable

dpvlink 2611

Article	Type
ASA250ML	ASA Antistatic spray, 250 ml aerosol can



AF Screen Clene wipes



The ultimate lens and screen cloth

- Ideal for cleaning the most types of glass and plastic lenses, including safety glasses, cameras, binoculars, microscopes, camcorders, and magnifying glasses
- Safe and easy to use
- Economical in use
- Protects against dust and veil formation
- Practically packed in a handy dispenser box
- antistatic, without alcohol, non-flammable

dpvlink 14789

Article Type

SCR100T

Screen Clene wipes
100 wipes/dispenser box

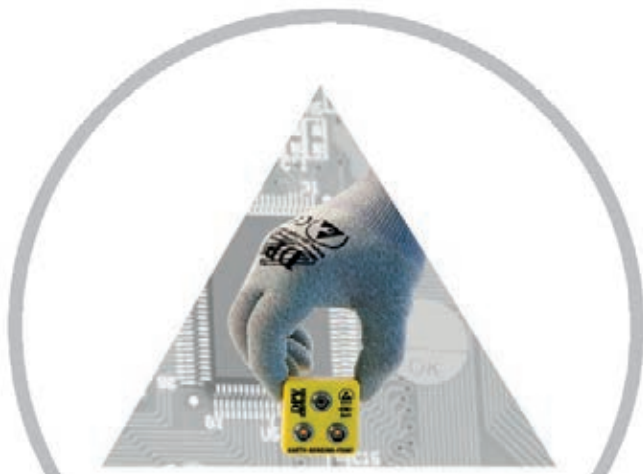

ESD

Cleaning of PCBs and metal parts

The effective cleaning of PCBs and metal parts does not only increase the reliability of the components, but facilitates also a safe coating.

Watery cleaning

Water-based products offers the environmentally safest cleaning method and an ideal long-term replacement for ozone-depleting solvents. They are extraordinarily effective, much cheaper than conventional cleaners in comparison with water-based solvents and easy and safe to use, whereas the level of residual dirt is lower than before.

Solvent-based cleaning

Solvents are quickly evaporating organic substances. The use of solvent-based cleaners may be required if PCBs or units contain unsealed components or water-sensitive devices.

Solvents

- Economically friendly
- Very good material compatibility
- Quick volatilization
- Suitable for service and repair work

Watery

- Biodegradable
- Non-flammable
- Cost-effective
- Economically friendly
- Very good material compatibility

All the following products are water-based and should not be stored at temperatures below 5°C. Disposal: All products have to be disposed in agreement with the local regulations.

Wässrige Reinigung

	SWA	SWAJ	SWAS	SWAP
	Safewash Original	Safewash Jigwash	Safewash Super	Safewash Pressure-wash
Maschinen Typen	Ultraschall	Ja	Ja	★★★★
	Druck-Spülmaschine / In-Line-Reinigung	Nein	Nein	Nein
	Druckumfluten im Tauchbad	Ja	Ja	Ja
	Sieb- und Schablonenreiniger	Nein	Nein	Nein
Schmutzentfernung	Schwere Fette (und organische Stoffe)	★★★☆☆	★★★★	★★★★
	„No-clean“-Flussmittel	Nein	★★★★	★★★★
	Flussmittel / ionische Kontaminationen	★★★★	★★★★	★★★★
	Nicht ausgehärtete Pasten	★★★★	★★★★	★★★★
Andere	Nicht ausgehärtete Kleber	Nein	Nein	Nein
	Für empfindliche Metalle geeignet	Nein	Ja	Ja
	Spülbarkeit	★★★★	★★★★	★★★★
Wenig schäumend	Nein	Nein	Nein	Ja

Wässrige Reinigung

	SWAT*	SWAX	SWMP	
	Safewash Total	Safewash Xtra	Safewash Mechanical Plus	
Maschinen Typen	Ultraschall	Ja	Ja	
	Druck-Spülmaschine / In-Line-Reinigung	★★★★	Ja	Nein
	Druckumfluten im Tauchbad	Ja	Ja	Ja
	Sieb- und Schablonenreiniger	Ja	★★★★	Nein
Schmutzentfernung	Schwere Fette (und organische Stoffe)	★★★★	Nein	★★★★
	„No-clean“-Flussmittel	★★★★	Nein	Nein
	Flussmittel / ionische Kontaminationen	★★★★	★★★★	Nein
	Nicht ausgehärtete Pasten	★★★★	★★★★	Nein
Andere	Nicht ausgehärtete Kleber	★★★★	★★★★	Nein
	Für empfindliche Metalle geeignet	Ja	Ja	Nein
	Spülbarkeit	★★★★	★★★★	★★★★
Wenig schäumend	Ja	Ja	Nein	

*Concentrates have to be diluted. You will find further information in the data sheet.

Lösungsmittel Reinigung

	HFFR	LFFR	FRC	ULS	DGC
	Hexanfreier Flussmittel-entferner	Entferner für bleifreie Flussmittel-rückstände	Nicht brennbarer Flussmittel-entferner	Ultrasolve-Reinigungs-lösung	Nicht brennbarer Entfetter
Typische Eigenschaften					
Dichte (g/ml)	0.78	0.78	1.33	0.79	1.33
Flammpunkt (°C)	7	0	Keiner*	-20	Keiner*
Siedepunkt (°C)	>80	>80	36	>80	36
Dampfdruck (kPa)	6	11.5	66.1	11.5	66.1
Verflüchtigungsrate (Ether = 1)	11	16	<1	16	<1
MAK (ppm)	300	300	242	300	242
Schmutzentfernung					
Schwere Fette (und organische Stoffe)	★★★★	★★★★	★★★★	★★★★	★★★★
„No-clean“-Flussmittel	★★★★	★★★★	★★★★	Nein	Nein
Flussmittel / ionische Kontaminationen	★★★★	★★★★	★★★★	★★★★	★★★★
Nicht ausgehärtete Pasten	★★★★	★★★★	★★★★	★★★★	★★★★
Nicht ausgehärtete Kleber	Nein	Nein	Nein	Nein	Nein

Lösungsmittel Reinigung

	IPA	ECSP	ULC	SSS
	Elektronik-Reinigungs-lösung	Elektronik-Reinigungs-lösung - Plus	Ultrasolve-Reinigungs-lösung	Sieb- und Schablonenreiniger
Typische Eigenschaften				
Dichte (g/ml)	0.79	0.79	0.79	1.03
Flammpunkt (°C)	12	-48	>60*	>60*
Siedepunkt (°C)	82	36	>173	>100
Dampfdruck (kPa)	4.4	53.3	0.5	1.45
Verflüchtigungsrate (Ether = 1)	6	1.5	66	>50
MAK (ppm)	400	500	300	300
Schmutzentfernung				
Schwere Fette (und organische Stoffe)	★★★★	★★★★	★★★★	Nein
„No-clean“-Flussmittel	Nein	Nein	Nein	Nein
Flussmittel / ionische Kontaminationen	★★★★	★★★★	Nein	Nein
Nicht ausgehärtete Pasten	★★★★	★★★★	★★★★	★★★★
Nicht ausgehärtete Kleber	Nein	Nein	Nein	★★★★

Evaporation rate: the higher the number, the lower the evaporation rate.
*classified as not flammable

SWA Foam cleaner

ELECTROLUBE



SWA cleaning

- For removing grease, dirt and flux
- Fast and efficient foaming
- Biodegradable and 100% ozone friendly

dpvlink 2561

Article	Type
SWA400H	SWA foam cleaner, 400 ml aerosol can



SWAT Safewash Total

ELECTROLUBE



SWAT Safewash Total

- High reserve capacities for an effective removal of impurities
- Contains no surfactants, easy to rinse
- Nonflammable
- Low foaming and odor formation
- Suitable for a variety of application methods

dpvlink 16404

Article	Type
SWAT05L	SWAT Safewash Total, 5 liter canister



ECSP Electronics cleaner Plus

ELECTROLUBE



ECSP electronics cleaner plus

- Removes grease, dirt, and the most flux types
- Rapidly evaporating cleaning solution
- Leaves absolutely no residues
- Highly flammable - may not be used on live devices

dpvlink 2535

Article	Type
ECSP200D	ECSP Electronics cleaner Plus, 200 ml aerosol can
ECSP200DB	ECSP Electronics cleaner Plus, 200 ml aerosol can with brush
ECSP400D	ECSP Electronics cleaner Plus, 400 ml aerosol can



-large container 6 liters available on request-

IPA Cleaning solvent

ELECTROLUBE



IPA cleaning solution

- Suitable for the cleaning of all electronic units and PCBs
- Cleans thoroughly and provides a completely dry and residue-free surface
- High-quality IPA for use in electronics
- Efficient and economical in application

dpvlink 2546

Article	Type
IPA400H	IPA Cleaning solvent, 400 ml aerosol can



- large container 1 / 5 / 25 liters available on request -

IPA cleaning cloths

ELECTROLUBE



IPA cleaning cloths

- lint-free cloths, pre-saturated with a mixture of 70% isopropanol and 30% demineralized water
- ideal for general cleaning applications
- removes also solder paste and inks
- degreasing properties
- reclosable

dpvlink 22073

Article	Type	Package size
IPA100	IPA 100 cleaning cloths	100 piece



ECW cleaning cloths

ELECTROLUBE



ECW cleaning cloths

- fiber of mixed cellulose and polyester
- very absorbent
- particular tear- and general resistance even in wet state

dpvlink 21883

Article	Type	L [mm]	W [mm]
ECW025	ECW cleaning cloths, 25 cloths/PU	340	340



EWI IPA cleaning cloths

ELECTROLUBE



EMI IPA cleaning cloths

- Ideal for cleaning all kinds of plugs
- Provides a temporary, antistatic agent
- Practically packed in individually sealed cloth bags

dpvlink 2544

Article	Type	L [mm]	W [mm]
EWI100	100 cloths/PU	220	230



CCC Contact cleaner

ELECTROLUBE



Non-flammable contact cleaner

- non-conductive, with high material compatibility
- instant drying
- almost no odors
- leaves no residues
- delivered with brush and extension tube

dpvlink 22086

Article	Type
CCC200DB	CCC Contact cleaner, 200 ml aerosol



CCS Contact cleaning strips

ELECTROLUBE



CCS contact cleaning strips

- Cleans, greases and repairs metal contacts
- High-quality contact lubricant
- Easy to use
- Impregnated, with gentle abrasion

dpvlink 7568

Article	Type
CCS020	Contact cleaning strips (20 pcs/ bag)



FLU Flux cleaner

ELECTROLUBE



FLU flux cleaner

- Compatible with most plastics, types of rubber and elastomers
- Leaves a perfectly clean and dry surface
- Very efficient cleaning
- available with brush attachment

dpvlink 2554

Article	Type
FLU200D	FLU Flux cleaner, 200 ml aerosol can
FLU400D	FLU Flux cleaner, 400 ml aerosol can
FLU400DB	FLU Flux cleaner, 400 ml aerosol can with brush



- large container 1 / 5 / 25 liters available on request -

HFFR Hexane-free flux remover

ELECTROLUBE



HFFR Hexane-free flux remover

- n-hexane-free
- efficient removal of all flux residues
- harmless to most plastics, rubbers and elastomers
- provides an absolutely clean and dry surface without residues

dpvlink 22084

Article	Type
HFFR400DB	HFFR Hexane-free flux remover, 400 ml aerosol with brush



LFFR Lead-free flux remover

ELECTROLUBE



LFFR lead-free flux remover

- Fast drying, solvent-based cleaner for a fast and thorough removal of process residues
- Efficiently in the use of R, RA, RMA and No-clean flux residues
- **für bleifrei Einsatz**
- Suitable for the removal of oils and lubricants
- Compatible with most plastics, types of rubber and elastomers
- Results in a perfectly clean and dry surface
- Leaves no oily deposits like other solvents
- 100% ozone friendly, low in odor

dpvlink 7574

Article	Type
LFFR400DB	LFFR Lead-free flux remover, 400 ml aerosol can with brush



SWAS Safewash Super flux cleaner

ELECTROLUBE



SWAS Safewash Super flux cleaner

- removes flux residues and No-Clean flux to military cleanliness standards
- low odor
- non-toxic
- suitable for the use stack cleaning systems with ultrasonic bath, dipping bath, and in the spraying machine/dishwasher

dpvlink 21890

Article	Type
SWAS05L	SWAS Safewash Super flux cleaner, 5 liters canister



Lead-free flux remover pen

Chemtronics



Lead-free flux remover pen CircuitWorks®

Pen for the exact removal of fluxes from PCBs.

- Removes the lead-free flux completely within seconds
- Can be used also for "previous" fluxes and tins
- Dries quickly
- **für bleifrei Einsatz**
- RoHS compliant
- Cleans smallest surfaces on PCB
- Controlled and accurate application by marking dispenser

dpvlink 7761

Article	Type
CW9400	Lead-free flux remover pin 9.0 g



Flux remover pens CircuitWorks



CircuitWorks® flux remover pens



Pen for a precise removal of fluxes from PCBs.

- Removes the flux completely within seconds
- Dries quickly
- Cleans smallest surfaces on PCBs
- Controlled and accurate application by marking dispenser

dpvlink 6316



Article	Type
CW9100	Flux remover pen No Clean 9.0 g
CW9200	Rosin flux remover pen 8.0 g

FLUX-OFF "Lead-free" flux remover



FLUX-OFF® "Lead-free" flux remover

Flux remover for the cleaning of lead-free fluxes with high temperature

- **für hohler Einsatz**
- Flammable - not for the use in live circuits
- Ozone friendly, CFC-/ HCFC-free
- Quickly drying
- Leaves no residues
- Removes flux from difficult to reach surfaces
- Removes residues of ionic and nonionic fluxes

dpvlink 7759



Article	Type
ES897.BE	FLUX-OFF "Lead-free" flux remover, 200 ml aerosol can with brush (BrushClean)

FLUX-OFF Water-soluble flux remover



FLUX-OFF® water-soluble flux remover

Flux remover for cleaning water-soluble and rosin-containing flux.

- Safe to use on plastics
- Flammable - not for the use in live circuits
- Ozone friendly, CFC-/ HCFC-free
- Dries quickly, without leaving any residues
- Removes fluxes of difficult to reach surfaces
- Removes residues of ionic and nonionic fluxes
- Safe to use on water-sensitive components

dpvlink 6313



Article	Type
ES830.BE	FLUX-OFF Water-soluble flux remover, 200 ml aerosol can with brush (BrushClean)

FLUX-OFF Rosin flux remover



FLOX-OFF® Rosin Flux Remover

Flux Remover for the cleaning of rosin and rosin-containing No-Clean flux.

- Safe to use on plastics
- Inflammable - not for the use on live circuits
- CFC-free
- Quickly drying, no residues
- Cleans difficult to reach areas

dpvlink 6309



Article	Type
ES835.BE	FLUX-OFF Rosin flux remover, 200 ml aerosol can with brush (BrushClean)

ULS Ultrasolve



ULS Ultrasolve

- Removes effectively greases, oils, flux residues and acrylic protective lacquers
- Compatible with most plastics and surface coatings
- Quickly drying solvent for a fast and efficient cleaning of electronic devices
- Leaves a clean, dry surface

dpvlink 2597



Article	Type
ULS12P	ULS Ultrasolve, 5 x 12 ml dispensing pens (PU)

dpvlink 6302



Article	Type
ULS200D	ULS Ultrasolve, 200 ml aerosol can
ULS400D	ULS Ultrasolve, 400 ml aerosol can
ULS400DB	ULS Ultrasolve, 400 ml aerosol can with brush

- large container 1 / 5 / 25 liters available on request -

SSW Screen / stencil cleaning wipes



SSW screen / stencil cleaning wipes

- Excellent cleaner for removing solder pastes and adhesives
- leaves a clean, dry and stainless surface
- Size: 200 x 280 mm
- Dispenser box with 100 wipes
- Low odor

dpvlink 2588



Article	Type
SSW100	SSW Screen / stencil cleaning wipes, 100 wipes in dispenser box

CCRG Protective lacquer remover



CCRG Protective lacquer remover

- For the removal of solvent-resistant lacquers (including DCA, DCB, DCR and others)
- Dichloromethane-free (DCM)
- thixotropic gel

dpvlink 16392



Article	Type
CCRG01L	CCRG Protective lacquer remover, 1 liter canister

Maintenance aids

BLV / BLR Screw locking varnish

ELECTROLUBE



BLV / BLR screw locking varnish

- Tamper-resistant seal for potentiometers etc.
- With integrated brush
- Available in red and green

dpvlink 2618

Article	Type
BLR15ML	Screw locking varnish Red Bloclube with 15 ml bottle
BLV15ML	Screw locking varnish Green Bloclube with 15 ml bottle



EAD Compressed air spray

ELECTROLUBE



EAD compressed air spray

- Inert, pure compressed air for dust removal, nonflammable
- Ideal for removing particles from inaccessible areas of sensitive devices

dpvlink 2829

Article	Type
EAD200D	EAD Compressed air spray 200 ml aerosol can
EAD400D	EAD Compressed air spray 400 ml aerosol can



EADPI Compressed air spray

ELECTROLUBE



EADPI compressed air spray

- Pure and inert air
- Due to extremely high pressure, impurities are removed easily and quickly
- The overhead function facilitates the cleaning in inaccessible places
- minimum order quantity: 12 pieces

dpvlink 10825

Article	Type
EADPI200D	EADPI Compressed air spray 200 ml aerosol can



EML Contact cleaner

ELECTROLUBE



EML contact cleaner

- Cleans and lubricates switches, plugs and slip rings
- Removes dirt and protects from further pollution
- Reduces the contact resistance
- Generally known as switch cleaner

dpvlink 6326

Article	Type
EML200F	EML Contact cleaner 200 ml aerosol can



FRE Freezer spray

ELECTROLUBE



FRE Freezer spray

- Standard cooling spray for an insensitive troubleshooting in electronic circuits
- Prevents a damage of the components during soldering
- Can support the mechanical process of press-fitting
- Cooling up to -55°C, nonflammable

dpvlink 2625

Article	Type
FRE400	FRE Freezer spray 400 ml aerosol can



MCF Cooling spray with minimal static charge

ELECTROLUBE



MCF cooling spray with minimal static charge

- Suitable for devices sensitive to electrostatic charge
- For a quick troubleshooting in electronic circuits
- A unique additive minimizes electrostatic charge and supports the cooling
- Antistatic protection
- Protection against overheating
- Cooling up to -55°C

dpvlink 7576

Article	Type
MCF200	MCF Cooling spray 200 ml aerosol can
MCF400	MCF Cooling spray 400 ml aerosol can



SCP Silver conductive paint

ELECTROLUBE



SCP silver conductive paint

- Ideal for track repair and accurate shielding
- Extremely conductive silver paint
- Optimal adhesion on most liners
- Dries quickly

dpvlink 2784

Article	Inhalt	Verpackung	VE
SCP Silver conductive paint			
SCP03B	3 ml	Bottle	35
SCP26G	26 g	Container	25



- only complete packaging units (PU) available -

LRM Label remover

ELECTROLUBE



dpvlink 6303

Article	Type
LRM200D	LRM Label remover 200 ml aerosol can
LRM200DB	LRM Label remover 200 ml aerosol can with brush



- large container 1 liter on demand-

Contact / Mechanical greasing



- Extends the lifetime of a switch
- Better signal quality
- adjustment of the switch sensation
- Prevents contamination
- silicone-free

Contact grease - Developed to create an improved reliability and long-term performance for the electrical and electronic equipment by ensuring a consistent and trouble-free current flow through all metal cut surfaces.

Mechanical lubricants - The range contains rust-solving oil, greases and dry lubricant in aerosols, syringes, cans and in large quantities.

Contact grease CG53A

ELECTROLUBE



Contact grease CG53A

- excellent electrical properties
- good plastic compatibility
- particularly good protection under tough conditions
- large operating temperature range

dpvlink 21877

Article	Type
CG53A35SL	35 ml syringe
CG53A01K	1 kg large container



SGA contact grease 2G

ELECTROLUBE



SGA contact grease 2G

- efficient treatment of all types of contacts
- reduces the contact resistance and arcing, from the small relay to high-performance switches
- will not migrate from vertical contacts or surfaces
- available as oil (SOA)

dpvlink 21885

Article	Type
SGA01K	1 kg container



SGB Contact grease 2GX

ELECTROLUBE



SGB contact grease 2GX

- Lubricates switches and electrical contacts
- Reduces the contact wear and the arcing
- Excellent plastic compatibility
- High-quality, not melting contact grease

dpvlink 2648

Article	Type
SGB20S	20 ml syringe
SGB35SL	35 ml syringe
SGB200D	200 ml aerosol can



dpvlink 6304

Article	Type
SGB01K	1 kg can



- large container 5 / 12.5 / 25 kg available on request -

SOB Contact oil 2X

ELECTROLUBE



SOB contact oil 2X

- Reduces arcing and thereby the contact wear
- Contact oil for switches and contacts
- Good mechanical properties
- Nonflammable and silicone-free

dpvlink 2650

Article	Type
SOB200D	200 ml aerosol can
SOB01K	1 kg large container



- large container 5 kg available on request -

Protective lacquers



- UL and MIL approval
- Solvent-resistant and removable lacquers
- Acrylics, silicones, polyurethanes and solvent-free
- UV traces for inspection
- Dilution and protective masks
- Dipping machine

Protective lacquers are special lacquers developed to protect PCBs and the associated equipment against environmental influences. They protect wirings against chemicals, vibrations, humidity, wetness and high temperatures that could cause corrosion, mold formation and current leakage leading to a failure in case of an uncoated PCB.

Protective lacquers improve the reliability and safety of PCBs and offer a life-time efficiency by creating a protective film that insulates the PCB protecting it against environmental influences like chemicals, humidity and other pollutants.

Protective lacquers facilitate a higher current and a shorter distance between the traces as they prevent current leakage.

Information on the application

Cleaning

PCBs have to be cleaned thoroughly before coating so that a maximum of adhesion can be reached. Flux residues have to be removed to prevent corrosion.

Environmental regulations

To use at min. 16°C or a relative humidity of 75%. As all PCBs absorb humidity, it has to be removed before coating so that the protective lacquer can completely develop his characteristics. Pre- and vacuum-drying are ideal for his purpose.

Film thickness

Depends on the application method.

Brushing or spraying

Mix the diluted lacquer well and let it rest for about 2 hours before spraying or brushing. Brush at room temperature with a natural fiber brush.

Dip coating

Dip the assemblies vertically. Dwell time approx. 1 minute. Pull them out slowly so that an even film is formed. For draining hang it over the tank.

Drying

Most of the protective lacquers have different drying times.

Schutz-lacke	AFA	DCA	FSC	HPA	LTC	SC-102	URC	UVCL	WBSP/WBPS
	freier Acrylack - Tauchlack-Version	Modifizierter Silbenschutzlack (SCC3)	Wiederentfernbarer modifizierter Silbenschutzlack	Hochleistungs-Acrylack	Niedertemperatur-Beschichtung	Silbenschichtung	Hohe Leisung Überbeschichtung	UV-härtender Schutzlack	Amesol Plus Tauch- / Spritz-Version
Verfügbare Farben	Klar	Klar / Schwarz / Rot	Klar	Klar	Klar	Klar	Klar	Klar	Klar
Viskosität (in mPa s bei 20°C) (Großgebinde)	175	200	350	300	150	300	240	180	200/80
Flammpunkt (°C) (Großgebinde)	-7	27	27	-7	-3	>90	27	>90	None
Feststoffgehalt (%) (Großgebinde)	35	37	55	35	25	100	45	100	33
Durchschlagsfestigkeit (kV/mm)	45	90	80	45	80	17	80	27	50
Oberflächenwiderstand (Ω)	1 x 10 ¹⁰	1 x 10 ¹⁰	1 x 10 ¹⁰	1 x 10 ¹⁰	1 x 10 ¹⁰	1 x 10 ¹⁰	1 x 10 ¹⁰	7 x 10 ¹⁰	5 x 10 ¹⁰
Temperaturbereich (°C)	-65 bis +125	-70 bis +200	-50 bis +125	-55 bis +130	-65 bis +130	-65 bis +200	-40 bis +130	-65 bis +125	-60 bis +125
Berührungstrocken nach (in Minuten bei 20°C)	5-10	50-55	10-15	10-15	10-15	<10	15	-	25-35
Aushärtezeit (in Stunden bei 20°C)	24	2 @ 20°C 5.2 @ 80°C	24	24	24	24	24	-	24
Lösungsmittelbeständigkeit	★★★★	★★★★	★★★	★★★★	★★★★	★★★★	★★★★	★★★★	★★★★
Feuchtigkeitsbeständigkeit	★★★★	★★★★	★★★	★★★★	★★★★	★★★★	★★★★	★★★★	★★★★
Beständigkeit gegen Schimmelbildung	★★★★	★★★★	★★★	★★★★	★★★★	★★★★	★★★★	★★★★	★★★★
Verdünner	FTH	DCT	DCT	UAT	LTC	k.A.	LOT	k.A.	Di Wasser
UV-Marker	Ja	Ja	Ja	Ja	Ja	Ja	Ja	Ja	Ja
Zulassungen	IPC-CC-830, UL746, (Erfüllt) BMW GS95011-5	UL746	IEC61080, UL746	MIL-46058G	(Erfüllt) BMW GS95011-5, IPC-CC-830, IEC61080	Erfüllt IPC-CC-830	Erfüllt IPC-CC-830	(Erfüllt) BMW GS95011-5, IPC-CC-830	

Schutz-lacke	2K100	2K300	2K500	FPC
	Hohe Leistung lösemittelfrei Urethan	Hohe Leistung lösemittelfrei Urethan	Hohe Leistung lösemittelfrei Urethan	Ultra-dünne Beschichtung
Verfügbare Farben	Klar	Klar	Klar	Klar
Viskosität (in mPa s bei 20°C) (Großgebinde)	2000	1500	1000	2
Flammpunkt (°C) (Großgebinde)	>100	>100	>100	>90
Feststoffgehalt (%) (Großgebinde)	100	100	100	2
Durchschlagsfestigkeit (kV/mm)	90	90	90	90
Oberflächenwiderstand (Ω)	2 x 10 ¹⁰	2 x 10 ¹⁰	5 x 10 ¹⁰	1 x 10 ¹⁰
Temperaturbereich (°C)	-40 bis +100	-40 bis +130	-40 bis +140	-40 bis +200**
Berührungstrocken nach (in Minuten bei 20°C)	240	240	240	1-5
Aushärtezeit (in Stunden bei 80°C)	10 mins @ 80°C	10 mins @ 80°C	10 mins @ 80°C	24
Lösungsmittelbeständigkeit	★★★★	★★★★	★★★★	★★★★
Feuchtigkeitsbeständigkeit	★★★★	★★★★	★★★★	★★★★
Beständigkeit gegen Schimmelbildung	★★★★	★★★★	★★★★	★★★★
Verdünner	k.A.	k.A.	k.A.	HFS
UV-Marker	Ja	Ja	Ja	Ja
Zulassungen	(Erfüllt) BMW GS95011-5, IPC-CC-830	Erfüllt IPC-CC-830	IPC-CC-830, BMW GS95011-5	Erfüllt UL746

*The SCC3 assortment can also cure at room temperature - in this case, however, the solvent resistance is lower.

For further information see the technical data sheet.

**depend on application and geometry

2K100, 2K500, UVCL, AFA, LTC and DCA have passed successfully the qualification of the BMW Group Standards GS95011.5

DCA/ DCR Transparent protective lacquer SCC3

ELECTROLUBE



DCA/DCR of transparent protective lacquer SCC3

- Resistant to most solvents
- Can be soldered through for reprocessing
- UL standard certified
- Suitable red version (DCR) suitable for camouflage

dpvlink 2717



Article	Type
DCA200H	transparent, 200 ml aerosol can
DCR200H	red, 200 ml aerosol can

dpvlink 7579



Article	Type
DCA01L	transparent, 1 liter container
DCA05L	transparent, 5 liter container
DCR05L	red, 5 liter container

- Thinner elastomer gel DRG available on request-

DCT diluent for protective lacquers without acrylic

ELECTROLUBE



DCT diluent for protective lacquers without acrylic

- can be applied to dilute non-acrylic protective lacquers when applying by dipping or spraying method
- normal dilution rate for spraying method is 2 parts lacquer to 1 part diluent

dpvlink 21880



Article	Type
DCT05L	5 liters canister

CPL Protective and soldering lacquer

ELECTROLUBE



CPL protective and soldering lacquer

- Universal protective lacquer for printed circuit boards
- An optimal corrosion protection for ferrous metals
- Good resistance to moisture
- Lacquer can be soldered through
- no UV trace
- can be used as top layer for conductive varnishes

dpvlink 2684



Article	Type
CPL200H	200 ml aerosol can

- large container 5 liters available on request -

AFA acrylic coating

ELECTROLUBE



AFA acrylic coating

- free from toluene and xylene
- UV trace to aid inspection
- Wide operating temperature range
- Excellent dielectric properties
- High resistance in humid environment and against salt mist

dpvlink 20340



Article	Type	Volume
AFA200	Acrylic protective coating spray can	200 ml

HCS Thermal cure silicone-based protective coating ELECTROLUBE



HCS Thermal cure silicone-based protective coating

- flexible coating, low mechanical stress on components
- quick and complete curing (10 minutes at 105°C)
- low odor and good adhesion
- fulfills the requirements of UL94 V-0

dpvlink 22335

Article	Type	Volume
HCS05L	HCS Thermal cure silicone-based protective coating	5 l



HPA Conformal Coating ELECTROLUBE



HPA Conformal Coating

- Excellent dielectric strength and a wide temperature range (-55° to 130°C)
- With UV trace for an easier control
- Can be removed with solvents such as Ultrasolve (ULS)
- Certified according to US MIL-1-46058C
- large container 1/5 liters and thinner available on demand

dpvlink 2700

Article	Type
HPA200H	200 ml aerosol can



APL Acrylic lacquer ELECTROLUBE



APL acrylic lacquer

- Lacquer may be soldered through, allows a simple repair
- Wide temperature range and good dielectric strength
- Offers excellent adhesion on all substrates
- UV trace for control
- Can be removed with solvents such as Ultrasolve (ULS)
- Large container 5 liters and thinner available on demand

dpvlink 2671

Article	Type
APL15ML	15 ml bottle
APL400H	400 ml aerosol can



PUC Polyurethane protective lacquer ELECTROLUBE



PUC polyurethane protective lacquer

- Excellent abrasion resistance and mechanical strength
- resistant mold growth
- excellent adhesion in any climatic conditions
- UV trace for an easier control
- Clear

dpvlink 7582

Article	Type
PUC400	400 ml aerosol can



WBP/WBPS Aquacoat Plus ELECTROLUBE



WBP / WBPS Aquacoat plus

- Protective lacquer based on water and polymer materials especially developed for electronic circuits
- Excellent dielectric properties
- Excellent adhesion on a wide range of substrates
- Very low VOC content
- Leaves a UV trace for an easy control
- Large working temperature range
- Mold-resistant
- Economically friendly

dpvlink 7586

Article	Type
WBP05LS	WBPS, 5 liter container (sprayable)



P.C. Flex Mask

P.C. Flex Mask is a solder resist mask made of latex rubber without solvent additives used for the protection of contacts, switches, connectors, plated-through holes and bare places on PCBs during the soldering process. It is also suitable for protecting electronic components against the contact with fluxes and cleaning agents. Afterwards, the mask can be easily peeled off and leaves no residues.



Technical data:

- Active ingredients: natural latex rubber
- Solid content: 63%
- Odor: slight odor of ammonia
- State: thixotrope paste
- Flashpoint: noninflammable
- Cure time at room temperature: approx. 40 min
- Cure time at 60°C: approx. 15 min
- Removability: 100 %
- Heat resistance: 268°C during soldering
- Durability (unopened) about 6 months

dpvlink 12251

Article	Type
C-330.202	P.C. Flex Mask, 237ml
C-330.204	P.C. Flex Mask, 3,8l



PCM Peelable solder resist mask ELECTROLUBE



PCM peelable solder resist mask

- Suitable for the use in the wave soldering process, does not peel off any solder when being removed
- Flexible latex for component cover
- Completely peelable by hand without leaving residues
- Solvent-resistant
- Pollutes no protective lacquers
- Dries at room temperature
- High film strength, hard to break

dpvlink 2751

Article	Type
PCM250ML	250 ml dispenser



PCS Ammonia-free peelable protective mask ELECTROLUBE



PCS peelable protective mask

- Protection for coating and wave soldering processes (für blödfrei Einsatz)
- Synthetic, flexible
- Ammonia-free, no odor
- Accelerated curing by heat
- Can be removed by hand without leaving any residue
- No discoloration caused by ammonia
- Improved durability

dpvlink 10034

Article	Type
PCS250ML	250 ml dispenser bottle



CHEMASK Peelable solder resist mask Chemtronics



CHEMASK® peelable solder resist mask

- Nonadhesive drying within 30 minutes
- Ideal for connectors, contacts, etc.
- Simple use - just peel off the dry mask
- Latex-based, peelable without leaving any residues
- Dispenser bottle with dispensing tip

dpvlink 6307

Article	Type
CLF8E	250 ml dispenser bottle LEAD-FREE
CM8E	250 ml dispenser bottle



Thermally conductive products

Thermal compounds are used for the heat dissipation in electronic and related equipment to ensure an effective function.

Most components have a maximum effective operating temperature. Exceeding that temperature can lead to two main problems:

- Increased failure rates
- Change of the electrical properties

The generated heat in the components is normally dissipated by the use of metals that may be shaped to create large surface areas (heat sinks). Usually the hot component is mechanically attached to the metal. The problem is that there will always be an air space between the surfaces.

As air is a bad heat conductor, this air space will considerably reduce the heat dissipation rate. Attaching a flexible and thermally conductive material fills the space completely and excludes the air. These products have excellent heat transfer properties, whereas the heat flows from the component into the metal body as fast as possible.

The range includes:

Heat transfer compounds

The most common pastes are silicone-based and have excellent stability at high temperatures.

The silicone-free pastes offer all advantages of silicone-based materials, eliminate, however, the risk of contamination by migrating free silicones causing the failure of a switch or a bad adhesion of coatings and protective films.

Epoxy resins

These two-part thermally conductive resin systems offer manufacturers a permanent mechanical adhesion between the component and the heat sink. That is why no mechanical fastening parts are needed. As PCBs are getting more complex and more powerful, the problem of heat generation must be treated in a careful way to ensure an optimum effectiveness and an increased life expectancy of the components. The use of these thermally conductive products offer an extremely cost-effective and efficient solution of the problem.

*RTVs need air humidity for curing. Higher temperature are only recommended if there is sufficient high humidity.

**These information should be considered as standard values only.

Wärmeleitprodukte

	HTCX	HTCP	HTCPX	HTS	HTSP
	Silikonfreie Wärmeleitpaste Xtra	Silikonfreie Wärmeleitpaste Plus	Silikonfreie Wärmeleitpaste Plus Xtra	Silikonhaltige Wärmeleitpaste	Silikonhaltige Wärmeleitpaste Plus
Wärmeleitfähigkeit (W/m.K)	1.35	2.50	3.40	0.90	3.00
Dichte (g/ml)	2.61	3.00	3.10	2.10	3.00
Viskosität (mPa s)**	130,000	105,000	640,000	210,000	45,000
Aushärtezeit (in Stunden bei 20°C / 60°C)	k. A.	k. A.	k. A.	k. A.	k. A.
Temperaturbereich (°C)	-50 to +130	-50 to +130	-50 to +130	-50 to +200	-50 to +200
Gewichtsverlust durch Verflüchtigung (96 Stunden bei 100 °C nach IP-183)	≤0.40%	≤1.00%	≤1.00%	≤0.80%	≤0.80%
Durchschlagsfestigkeit (kV/mm)	42	42	42	18	18
Spezifischer Durchgangswiderstand (Ω*cm)	1 x 10 ¹⁴	1 x 10 ¹⁴	1 x 10 ¹⁴	1 x 10 ¹⁵	1 x 10 ¹⁵

Wärmeleitprodukte

	TCOR	ER2220	ER2221	UR5633	SC2003
	Wärmeleitfähiger RTV	Zweikomponenten-Epoxydharz	Zweikomponenten-Epoxydharz	Zweikomponenten-Polyurethanharz	Zweikomponenten-Silikonharz
Wärmeleitfähigkeit (W/m.K)	1.80	1.54	1.20	1.24	0.80
Dichte (g/ml)	2.30	2.22	1.88	1.65	1.60
Viskosität (mPa s)**	145,000	15,000	3,000	30,000	30,000
Aushärtezeit (in Stunden bei 20°C / 60°C)	24*	24/4	24/2	24/4	24/1
Temperaturbereich (°C)	-50 to +230	-40 to +130	-40 to +150	-50 to +125	-60 to +200
Gewichtsverlust durch Verflüchtigung (96 Stunden bei 100 °C nach IP-183)	N/A	N/A	N/A	N/A	N/A
Durchschlagsfestigkeit (kV/mm)	>8	10	17.7	16	20
Spezifischer Durchgangswiderstand (Ω*cm)	1 x 10 ¹⁴	1 x 10 ¹⁵	1 x 10 ¹⁶	1 x 10 ¹⁴	1 x 10 ¹⁵

*RTVs need air humidity for curing. Higher temperature are only recommended if there is sufficient high humidity.

**These information should be considered as standard values only.

GP 300 Thermal conductive film



GP 300 Thermal conductive film

- 200 x 200 mm thermal conductive film
- different thicknesses available
- quick and easy treatment
- very well electrical insulation
- large operating temperature range -50°C - 160°C
- thermally conductive, 3W/m K

dpvlink 22044

Article	Type
GP300S	Thermal conducting film 200 x 200 x 0.5 mm
GP300SL	Thermal conducting film 200 x 200 x 1 mm



TBS Thermally conductive adhesive



TBS thermally conductive adhesive

- By forming a permanent adhesive binding a mechanical fastening is unnecessary
- Two-component adhesive
- Very good thermal conductivity (1.1 W/mK)

dpvlink 2814

Article	Inhalt	Verpackung	Stück/VE
TBS20S	20 ml	Syringe	10



- only complete packaging units (PU) available -

HTC / HTCP Silicone-free thermally conductive paste



HTC/HTCP silicone-free thermally conductive paste

- Excellent non-creep properties
- Silicone-free thermally conductive paste
- Thermal conductivity: HTC = 0.9 W/mK, HTCP = 2.5 W/mK
- Easy and economical in use

dpvlink 2788

Article	Type	Packaging type	PU
HTC02S	Thermally conductive paste HTC02S	2 ml syringe	10 piece
HTC10S	Thermally conductive paste HTC10S	10 ml syringe	1 piece
HTC20S	Thermally conductive paste HTC20S	20 ml syringe	1 piece
HTC35SL	Thermally conductive paste HTC35SL	35 ml syringe	1 piece
HTC700G	Thermally conductive paste HTC700G	700 g cartridge	1 piece
HTCP20S	Thermally conductive paste HTCP20S	20 ml syringe	1 piece
HTC01K	Thermally conductive paste HTC01K	1 kg container	4 piece



HTCX/ HTPCX Silicone-free thermally conductive paste Xtra

ELECTROLUBE



HTCX/HTPCX silicone-free thermally conductive paste

- Excellent non-creep properties
- Thermal conductivity: HTPCX = 3.40 W/mK, HTPCX = 2.28 W/mK
- Very low weight loss by evaporation of the used carrier oil
- Easy and economical in use

dpvlink 16399



Article	Type	Packaging type	PU
HTCPX700G	Thermally conductive paste HTPCX700G	700 g cartridge	1 piece
HTCX35SL	Thermally conductive paste HTPCX35SL	35 ml syringe	10 piece
HTCX01K	Thermally conductive paste HTPCX01K	1 kg container	4 piece
HTCX700G	Thermally conductive paste HTPCX700G	700 g cartridge	1 piece

HTS / HTSP Silicone-based thermally conductive compound

ELECTROLUBE



HTS / HTSP Silicone-containing thermally conductive compound

- Excellent non-creep properties
- Silicone-based thermal conductive compound
- Thermal conductivity: HTS = 0.9 W/mK, HTSP = 3.0 W/mK
- Large temperature range
- low loss in weight due to evaporation
- economical and easy to use

dpvlink 2806



Article	Type	Packaging type	PU
HTS10S	Thermally conductive compound HTS10S	10 ml syringe	24 piece
HTS35SL	Thermally conductive compound HTS35SL	35 ml syringe	10 piece
HTS01K	Thermally conductive compound HTS01K	1 kg container	4 piece
HTSP50T	Thermally conductive compound HTSP50T	50 ml tube	1 piece
HTSP01K	Thermally conductive compound HTSP01K	1 kg container	4 piece

- only complete packaging units (PU) available -

TCER / TCOR Thermally conductive rubber

ELECTROLUBE



TCER /TCOR thermally conductive rubber

- High thermal conductivity TCER 2.2 W/mK, TCOR: 1.8 W/mK
- Wide temperature range from -50°C to + 230°C
- Cures in 24 hours at room temperature
- Silicone thermally conductive rubber

dpvlink 7591



Article	Type
TCOR75S	75 ml cartridge TCOR75S
TCRGUN	Dispensing gun for TCOR75S

-700 g cartridge available on request-

Potting compounds



- UL approved
- Encapsulation and potting
- Seals, cable connection
- Protection and sealing

The potting compounds systems are designed to insulate and protect electrical and electronic components from the dangers of a rough and challenging environment, moisture, vibration, thermal and physical shocks, as well as general pollution.

Potting compounds can form a complete barrier against environmental influences, a complete insulation of assembly parts and are better suited for the operation under extreme conditions than protective lacquers.

Potting compound types used in the electronics industry are epoxy resin and polyurethane.

Further information about potting compounds is available in our online shop.

Epoxy potting compound

ELECTROLUBE

Epoxidharze	ER2188	ER2074	ER2183
Farbe (vermishtes System)	Schwarz	Weiß	Schwarz
Dichte in ausgehärtetem Zustand (g/ml)	1.69	2.09	1.95
Viskosität des vermishten Systems (in mPa s bei 23°C)	9000	16700	5000
Mischverhältnis nach Gewicht (nach Volumen)	11:1 (5.5 : 1)	17.31 : 1 (7.23 : 1)	12.78 : 1 (5.58 : 1)
Topfzeit (in Minuten bei 23°C)	60	90	120
Gelzeit (in Minuten bei 23°C)	150	300	420
Aushärtezeit (in Stunden bei 23°C / 60°C)	24/2	24/4	24/4
Wärmeleitfähigkeit (W/m.K)	0.91	1.26	1.25
Temperaturbereich (°C)	-40 bis +120	-40 bis +130	-40 bis +130
Höchsttemperatur – kurzfristig (°C)	+140	+150	+150
Durchschlagsfestigkeit (kV/mm)	10	10	10
Spezifischer Durchgangswiderstand (D*cm)	10 ¹⁴	10 ¹⁵	10 ¹⁵
Shore-Härte	D85	D80	D80
Flammhemmung	V-0	V-0	V-0
UL94-Zertifizierung	Ja	Nein	Nein
RoHS konform	Ja	Ja	Ja

dpvlink 2819



Article	Type
ER2074RP250G	Epoxy potting compound ER2074RP250G, 250 g packing Thermally conductive, flame-retardant, without abrasive filling agent, color: white, PU = 10 pieces Application example: Potting of printed circuit boards, generators, current transformers, temperature sensors
ER2074K5K	Epoxy potting compound ER2074K5K, 5kg container PU = 1 piece
ER2188RP250G	Epoxy potting compound ER2188RP250G, 250 g packing DDM-free, flame-retardant, all purpose of potting resin, UL94V-0-certified, color: black, PU = 10 pieces Application example: Potting and encapsulation applications where flame retardancy is required
ER2188K5K	Epoxy potting compound ER2188K5K, 5kg container PU = 1 piece

dpvlink 2819



Article	Type
ER2183RP250G	Epoxy potting compound ER2183RP250G, 250 g packing Alternative to ER2074RP250G with low viscosity, improved machine mix and output Color: black, PU = 10 pieces Application example: ABS systems, pressure sensors, temperature sensors, performance elements
ER2183K5K	Epoxy potting compound ER2183K5K, 5kg container PU = 1 piece

- only complete packaging units (PU) available -

Polyurethane potting compounds

ELECTROLUBE

Polyurethanharze	UR5041	UR5048	UR5044	UR5528
Farbe (vermishtes System)	Schwarz	Klar bernsteinfarben	Dunkelblau	Schwarz
Dichte in ausgehärtetem Zustand (g/ml)	1.18	0.95	1.58	1.07
Viskosität des vermishten Systems (in mPa s bei 23°C)	2500	980	3400	2000
Mischverhältnis nach Gewicht (nach Volumen)	3.6:1 (3.9:1)	14:1 (19:1)	13.4:1 (11.7:1)	2.4:1 (2.9:1)
Topfzeit (in Minuten bei 23°C)	20	20	25	20
Geliezeit (in Minuten bei 23°C)	60	40	40	35
Aushärtezeit (in Stunden bei 23°C / 60°C)	24/2	24/4	24/3	24/5
Wärmeleitfähigkeit (W/m.K)	0.25	0.20	0.60	0.25
Temperaturbereich (°C)	-60 bis +125	-60 bis +100	-70 bis +120	-50 bis +125
Höchsttemperatur – kurzfristig (°C)	+130	+100	+130	+130
Durchschlagsfestigkeit (kV/mm)	20	18	17.7	25
Spezifischer Durchgangswiderstand (Ω•cm)	10 ¹⁵	10 ¹⁴	10 ¹⁵	10 ¹⁴
Shore-Härte	A85	A12	A40	D75
Flammhemmung	-	-	V-0	-
UL94-Zertifizierung	Nein	Nein	Ja	Nein
RoHS konform	Ja	Ja	Ja	Ja

Epoxidharze	UR5097	UR5547	UR5608
Farbe (vermishtes System)	Schwarz	Schwarz	Schwarz
Dichte in ausgehärtetem Zustand (g/ml)	1.49	1.60	1.59
Viskosität des vermishten Systems (in mPa s bei 23°C)	6000	4000	2000
Mischverhältnis nach Gewicht (nach Volumen)	7.46 : 1 (6.01 : 1)	5.5 : 1 (4 : 1)	6.93 : 1 (5.18 : 1)
Topfzeit (in Minuten bei 23°C)	20	20	50 - 100
Geliezeit (in Minuten bei 23°C)	80	50	90 - 240
Aushärtezeit (in Stunden bei 23°C / 60°C)	24/4	24/3	24/3
Wärmeleitfähigkeit (W/m.K)	0.65	0.65	0.78
Temperaturbereich (°C)	-40 bis +110	-50 bis +120	-40 bis +135
Höchsttemperatur – kurzfristig (°C)	+130	+125	+145
Durchschlagsfestigkeit (kV/mm)	18	14	18
Spezifischer Durchgangswiderstand (Ω•cm)	10 ¹⁴	10 ¹⁴	10 ¹⁴
Shore-Härte	A85	A85	D50
Flammhemmung	V-0	V-0	V-0
UL94-Zertifizierung	Ja	Nein	Ja
RoHS konform	Ja	Ja	Ja

dpvlink 2824



Article	Type
UR5044RP250G	Polyurethane potting compound UR5044RP250G, 250g packing Flame-retardant, very flexible, low shore-hardness Color: blue, PU = 10 pieces Application: Replacement for silicone, control units for shock absorbers, vibrations, prototypes

UR5044K5K	Polyurethane potting compound UR5044K5K, 5kg container PU = 1 piece
-----------	---

UR5048RP250GE	Polyurethane potting compound UR5048RP250GE, 250g packing Repairable, transparent potting compound allows a quick troubleshooting, water-repellent Color: transparent, PU = 10 pieces Application example: Encapsulation of sensitive components like ferrites, coils and glass reed switches
---------------	---

UR5048K5K	Polyurethane potting compound UR5048K5K, 5kg container PU = 1 piece
-----------	---

UR5097RP250G	Polyurethane potting compound UR5097RP250G, 250g packing Low flexible, flame-retardant resin, high water resistance and very good electrical properties, can be used as replacement for silicone. Color: black, PU = 10 pieces Application example: Cable connectors, coils, switches, sensors, gears, transformers, relays etc.
--------------	--

UR5097K5K	Polyurethane potting compound UR5097K5K, 5kg container PU = 1 piece
-----------	---

UR5608RP250G	Polyurethane potting compound UR5608RP250G, 250g package Low flexible, flame-retardant PU with high hardness, chemical and adhesive properties, low coefficient of expansion, high thermal conductivity, can be used as alternative for epoxy resin. Color: black, PU = 10 pieces Application example: Cable connectors, PCBs, transformers, connectors, ignition coils, alarms etc.
--------------	--

UR5041RP250G	Polyurethane potting compound UR5041RP250G, 250g package Low level of water absorption, high resistance to sea water, good adhesive properties on substrates Color: black, PU = 10 pieces Application example: Coating in harsh maritime environments
--------------	---

UR5041K5K	Polyurethane potting compound UR5041K5K, 5kg container PU = 1 piece
-----------	---

UR5528RP250G	Polyurethane potting compound UR5528RP250G, 250g package Water-repellent, tough and elastic, excellent adhesive properties on difficult substrates, low viscosity, excellent resistance to acids, alkalis and other aqueous substances. Color: black, PU = 10 pieces Application example: PVC, ceramic, moist environment
--------------	---

UR5528K5K	Polyurethane potting compound UR5528K5K, 5kg container PU = 1 piece
-----------	---

UR5547RP500G	Polyurethane potting compound UR5547RP500G, 500g package Flame-retardant resin, exerts very little pressure even after curing Color: black, PU = 10 pieces Application example: Encapsulation of sensitive components such as ferrites, ideal for ceramics
--------------	--

- only complete packaging units (PU) available -

Silicone resin potting compound

ELECTROLUBE

Epoxidharze	SC4003E
Farbe (vermishtes System)	Schwarz
Dichte in ausgehärtetem Zustand (g/ml)	1.43
Viskosität des vermishten Systems (in mPa s bei 23°C)	3500
Mischverhältnis nach Gewicht (nach Volumen)	1 : 1 (1 : 1)
Topfzeit (in Minuten bei 23°C)	45
Geliezeit (in Minuten bei 23°C)	180
Aushärtezeit (in Stunden bei 23°C / 60°C)	24/(N/A)
Wärmeleitfähigkeit (W/m.K)	0.7
Temperaturbereich (°C)	-60 bis +200
Höchsttemperatur – kurzfristig (°C)	+220
Durchschlagsfestigkeit (kV/mm)	22
Spezifischer Durchgangswiderstand (Ω•cm)	10 ¹⁴
Shore-Härte	A75
Flammhemmung	V-0
UL94-Zertifizierung	Nein
RoHS konform	Ja

SC4003

SC4003E is a two-component silicone casting resin for the protection of electronic devices. It offers a wide temperature range and is very suitable for applications requiring operating temperatures of up to 200°C.

[dpvlink 16391](#)

Article Type

SC4003ERP250G **Silicone potting compound SC4003, 250 g pack**

- only complete packaging units (PU) available -



Resin remover

ELECTROLUBE

[dpvlink 16266](#)

Article Type

RRS05L **Resin remover**
5 liter canister, quickly evaporating solvent, removes hardened epoxies and polyurethanes, without methylene chloride

